

E-M-HC2 Probes-V1_10 Document code	Rotronic AG Bassersdorf, Switzerland Unit
HygroClip 2 (HC2) Humidity Temperature Probes – User Guide Document title	Instruction Manual Document Type
	Page 1 of 29

HygroClip 2 (HC2) Humidity Temperature Probes User Guide



E-M-HC2 Probes-V1_10	Rotronic AG Bassersdorf, Switzerland
Document code	Unit
HygroClip 2 (HC2) Humidity Temperature Probes – User Guide	Instruction Manual
	Document Type
Document title	Page 2 of 29

Table of contents

1	Overview	3
1.1	Hardware and software compatibility	3
2	Models	4
3	General description	11
3.1	Power supply.....	11
3.2	Measured parameters	11
3.3	Calculated parameters	11
3.4	Analog output signals	11
3.5	Digital interface	12
3.6	Sensor protection (dust filter)	12
4	Functions	12
5	User configurable settings	13
6	Mechanical installation	13
6.1	General guidelines for fixed installation.....	13
7	Electrical installation	14
7.1	General guidelines for fixed installation.....	14
7.2	Connector	15
7.3	Wiring color code	16
7.4	Analog signal wiring	16
7.5	Minimum analog output load	16
7.6	Digital signal wiring	17
7.7	Grounding	17
8	Operation	17
8.1	Operation with an indicator, data logger or transmitter.....	17
8.2	Analog probe operation (stand-alone).....	17
8.3	PC or network operation	17
8.4	Hand-held probes.....	17
9	Maintenance	18
9.1	Cleaning or replacing the dust filter.....	18
9.2	Periodic calibration check	18
9.3	Validation of the output signals transmission	18
10	Firmware updates	19
11	Technical data	20
11.1	Specifications	20
11.2	Dew point accuracy.....	22
12	Accessories	23
12.1	Configuration and communication software	23
12.2	Passive extension cables.....	23
	Extension cables with digital signal booster	24
12.3	Digital interface adapters	24
12.4	Connectors and passive cables for OEM applications	24
12.5	Cables with built-in voltage adapter for OEM applications	25
12.6	Mounting hardware	26
12.7	Calibration accessories.....	26
12.8	Dust filters.....	26
12.9	Filter spare parts	28
13	Supporting documents	29
14	Document releases	29

E-M-HC2 Probes-V1_10	Rotronic AG Bassersdorf, Switzerland
Document code	Unit
HygroClip 2 (HC2) Humidity Temperature Probes – User Guide	Instruction Manual
	Document Type
Document title	Page 3 of 29

Applicability:

This manual applies to all HC2 probes with firmware version 1.x, where 1.x can be 1.0, 1.1, etc. Changes to the last digit of the version number reflect minor firmware changes that do not affect the manner in which the probe should be operated.

1 Overview

The HC2 series are digital humidity-temperature probes based on the AirChip 3000 technology. These probes feature a UART serial interface and two 0...1 V linear analog output signals.

The HC2 probes are designed for use with the HygroClip 2 generation of ROTRONIC humidity-temperature instruments: hand-held and bench top indicators, data loggers, transmitters, hygrometers, etc. The HC2 probes maintain all of the benefits of the original HygroClip technology such as the possibility of hot-swapping probes and feature significant improvements in the area of measurement accuracy and functionality.

The HC2 probes can also be used as a stand-alone device using either the analog output signals or the probe digital interface. Connectors, cables and digital interface adapters are available to this purpose. Digital integration with OEM applications is facilitated by the UART interface and by the AirChip 3000 communication protocol (see: supporting documents).

The HC2 probes offer the following user functions:

- User configurable settings
- Calculation of the dew or frost point
- Humidity temperature calibration and adjustment
- Simulator mode
- Automatic humidity sensor test and drift compensation
- Sensor failure mode
- Data recording

The ability for the user to easily update the AirChip 3000 firmware means that the HC2 probes can be kept up-to-date regarding any future functionality improvement.

Available in different configurations, the HC2 probe series is designed to meet the requirements of a large number of applications and environments.

1.1 *Hardware and software compatibility*

The HC2 probes are compatible only with the HygroClip 2 generation of ROTRONIC humidity-temperature instruments and are not backward compatible with instruments based on the original HygroClip technology.

Configuration of the HC2 probes and access to the probe functions requires a PC with the ROTRONIC HW4 software version 2.1.0 or higher or connection to a compatible instrument from ROTRONIC.

E-M-HC2 Probes-V1_10	Rotronic AG Bassersdorf, Switzerland
Document code	Unit
HygroClip 2 (HC2) Humidity Temperature Probes – User Guide	Instruction Manual
	Document Type
Document title	Page 4 of 29

2 Models

In the following tables, we have indicated the type of instrument primarily used with each probe model. The following should also be noted:

- The HC2 probes can be directly connected to a PC or to an Ethernet network using one of the available digital interface adapters (see Accessories).
- The HC2 Probes can also be used as a stand alone device with two analog output signals. Different connectors are available to this purpose (see Accessories). Regardless of the probe model, the analog outputs signals are always scaled in the same way by the factory (0...1 V = 0...100 %RH and 0...1 V = -40...60 °C). The user is responsible for reconfiguring the probe analog outputs (requires the ROTRONIC HW4 software) and for providing power to the probe.

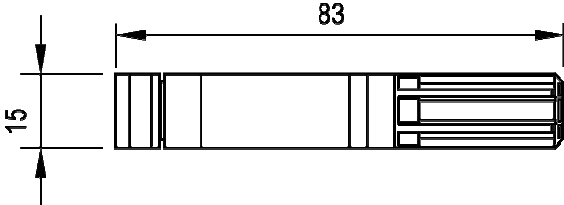
Climate measurement	
<i>For use with indicators, data loggers and transmitters, with or without an extension cable</i>	
HC2-S	Humidity measuring range: 0...100 %RH Temperature limits -40...100 °C (-40...212 °F) Diameter: 15mm (0.6"), length: 85 mm (3.3") Housing and filter cap: polycarbonate, black Polyethylene dust filter Accurate measurements require full immersion in the environment to be measured Weight: approx. 10 g (0.35 oz)
HC2-S3	Same as HC2-S but with white housing and filter cap for outdoor use
	

E-M-HC2 Probes-V1_10	Rotronic AG Bassersdorf, Switzerland
Document code	Unit
HygroClip 2 (HC2) Humidity Temperature Probes – User Guide	Instruction Manual
Document title	Document Type
	Page 5 of 29

Measurement in tight spaces

For use with indicators, data loggers and transmitters

HC2-C04	Humidity measuring range: 0...100 %RH Temperature limits -40...100 °C (-40...212 °F) Diameter: 4 mm (0.16"), cable length (electronics – probe tip: about 2 m (6.5 ft)) Probe body: polycarbonate, black Weight: approx. 150 g (5.3 oz)
HC2-C05	Same as HC2-C04 but with 5 mm diameter (0.2") Can be equipped with a dust filter (see Accessories) Weight: approx. 160 g (5.6 oz)

Spot check measurements in air ducts, chambers and ovens

Handheld probe for use with indicators and data loggers

HC2-HK25	Humidity measuring range: 0...100 %RH Temperature limits at sensor -100...150 °C (-148...302 °F) Barrel: diameter: 15 mm (0.6"), length: 250 mm (9.8") Probe cable length: 2 m (6.5 ft) Handgrip: POM, black -, barrel: PPS, black Nickel plated brass filter base and wire mesh filter cartridge Weight: approx. 210 g (7.4 oz)
HC2-HK40	Humidity measuring range: 0...100 %RH Temperature limits at sensor -100...200 °C (-148...392 °F) Same as HC2-HK25 but with barrel 400 mm barrel length (15.7") Weight: approx. 240 g (8.5 oz)

E-M-HC2 Probes-V1_10	Rotronic AG Bassersdorf, Switzerland
Document code	Unit
HygroClip 2 (HC2) Humidity Temperature Probes – User Guide	Instruction Manual
	Document Type
Document title	Page 6 of 29

Measurement of dust-free granular products in bulk

Handheld probe for use with indicators and data loggers

HC2-P05	Humidity measuring range: 0...100 %RH Temperature limits -40...85 °C (-40...185 °F) Barrel: diameter: 5 mm (0.2"), length: 200 mm (7.9") Probe cable length: 2 m (6.5 ft) Handgrip: POM, black - barrel: stainless steel Weight: approx. 160 g (5.6 oz)
---------	--

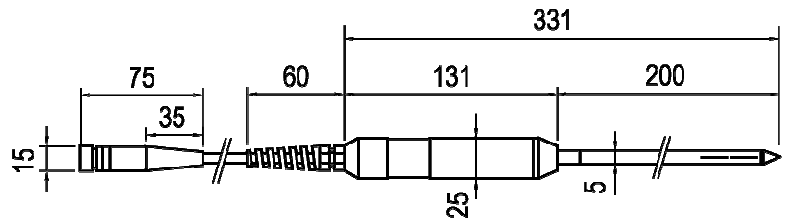

Measurement of seeds, granulates and powders in bulk

Handheld probe for use with indicators and data loggers

HC2-HP28	Humidity measuring range: 0...100 %RH Temperature limits at sensor -40...85 °C (-40...185 °F) Barrel: diameter: 10 mm (0.4"), length: 280 mm (11.0") Probe cable length: 2 m (6.5 ft) Handgrip: POM, black - barrel: stainless steel Nickel plated brass filter base and sintered steel filter cartridge Weight: approx. 200 g (7.1 oz)
----------	---

HC2-HP50	Humidity measuring range: 0...100 %RH Same as HC2-HP28 but with barrel 500 mm barrel length (19.7") Weight: approx. 250 g (8.8 oz)
----------	--

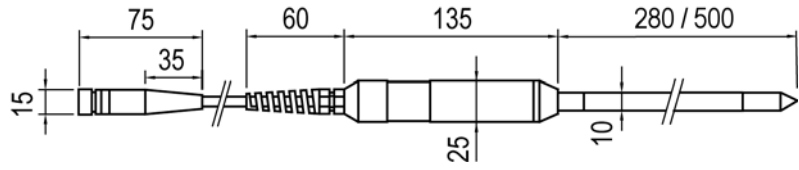

E-M-HC2 Probes-V1_10	Rotronic AG Bassersdorf, Switzerland
Document code	Unit
HygroClip 2 (HC2) Humidity Temperature Probes – User Guide	Instruction Manual
Document title	Document Type
	Page 7 of 29

Measurement of paper – cardboard stacks and rolls	
<i>Handheld probe for use with indicators and data loggers</i>	
HC2-HS28	Humidity measuring range: 0...100 %RH Temperature limits at sensor -40...85 °C (-40...185 °F) Blade: thickness: 4 mm (0.16"), width: 22 mm (0.87"), length: 280 mm (11.0") Probe cable length: 2 m (6.5 ft) Weight: approx. 240 g (8.5 oz) Handgrip: POM, black - blade: aluminum
HC2-HS42	Same as HC2-HS28 but with 420 mm blade length (16.5") Weight: approx. 300 g (10.6 oz)

Process measurement (fixed installation)	
<i>For use with transmitters and data loggers</i>	
HC2-IC102 HC2-IC105 HC2-IC110	Humidity measuring range: 0...100 %RH Temperature limits at sensor -100...200 °C (-148...392 °F) Barrel: diameter: 15 mm (0.6"), length: 100 mm (3.9"). See note below Probe cable length.: 2 m (6.5 ft) or 5 m (16.4 ft) or 10 m (32.8 ft) Barrel: polycarbonate, black Nickel plated brass filter base. Filter to be ordered separately Weight: with 2 m cable approx. 230 g (8.1 oz), + 80 g (2.8 oz) per additional meter
HC2-IC302 HC2-IC305 HC2-IC310	Same as HC2-IC1xx but with 250 mm barrel length(9.8") for through wall installation Weight: with 2 m cable approx. 260 g (9.2 oz), + 80 g (2.8 oz) per additional meter

Note: HC2-IC1 (100 mm barrel length) – to avoid measurement errors due to temperature gradients fully immerse the probe barrel in the environment to be measured

E-M-HC2 Probes-V1_10	Rotronic AG Bassersdorf, Switzerland
Document code	Unit
HygroClip 2 (HC2) Humidity Temperature Probes – User Guide	Instruction Manual
	Document Type
Document title	Page 8 of 29

Process measurement (fixed installation)

For use with transmitters and data loggers

HC2-IC302-A HC2-IC305-A HC2-IC310-A	Humidity measuring range: 0...100 %RH Temperature limits at sensor -100...200 °C (-148...392 °F) Barrel: diameter: 25 / 15 mm (1.0 / 0.6"), length: 250 mm (9.8") Probe cable length.: 2 m (6.5 ft) or 5 m (16.4 ft) or 10 m (32.8 ft) Barrel: polycarbonate, black Nickel plated brass filter base. Filter to be ordered separately Designed for through wall installation Weight with 2 m cable: approx. 290 g (10.2 oz), + 80 g (2.8 oz) per additional meter
HC2-IC402-A HC2-IC405-A HC2-IC410-A	Same as HC2-IC3xx-A but with 400 mm barrel length(15.7") Weight with 2 m cable: approx. 320 g (11.3 oz), + 80 g (2.8 oz) per additional meter
HC2-IC502-A HC2-IC505-A HC2-IC510-A	Same as HC2- IC3xx-A but with 550 mm barrel length(21.6") Weight with 2 m cable: approx. 350 g (12.3 oz), + 80 g (2.8 oz) per additional meter
HC2-IC702-A HC2-IC705-A HC2-IC710-A	Same as HC2- IC3xx-A but with 700 mm barrel length(27.5") Weight with 2 m cable: approx. 380 g (13.4 oz), + 80 g (2.8 oz) per additional meter

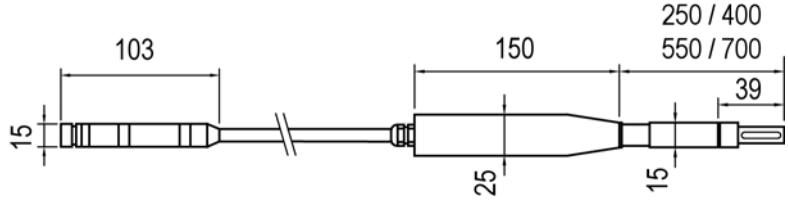

E-M-HC2 Probes-V1_10	Rotronic AG Bassersdorf, Switzerland
Document code	Unit
HygroClip 2 (HC2) Humidity Temperature Probes – User Guide	Instruction Manual
Document title	Document Type
	Page 9 of 29

Process measurement (fixed installation)

For use with transmitters and data loggers

HC2-IM102 HC2-IM105 HC2-IM110	Humidity measuring range: 0...100 %RH Temperature limits at sensor -100...200 °C (-148...392 °F) Barrel: diameter: 15 mm (0.6"), length: 120 mm (4.7"). See note below Probe cable length.: 2 m (6.5 ft) or 5 m (16.4 ft) or 10 m (32.8 ft) Barrel: stainless steel Nickel plated brass filter base. Filter to be ordered separately Weight with 2 m cable: approx. 260 g (9.2 oz), + 80 g (2.8 oz) per additional meter
HC2-IM302 HC2-IM305 HC2-IM310	Same as HC2-IM1xx but with 280 mm barrel length(11.0") for through wall installation Weight with 2 m cable: approx. 400 g (14.1 oz), + 80 g (2.8 oz) per additional meter
HC2-IM402 HC2-IM405 HC2-IM410	Same as HC2-IM1xx but with 430 mm barrel length(16.9") for through wall installation Weight with 2 m cable: approx. 540 g (19.0 oz), + 80 g (2.8 oz) per additional meter
HC2-IM502 HC2-IM505 HC2-IM510	Same as HC2-IM1xx but with 580 mm barrel length(22.8") for through wall installation Weight with 2 m cable: approx. 680 g (24.0 oz), + 80 g (2.8 oz) per additional meter

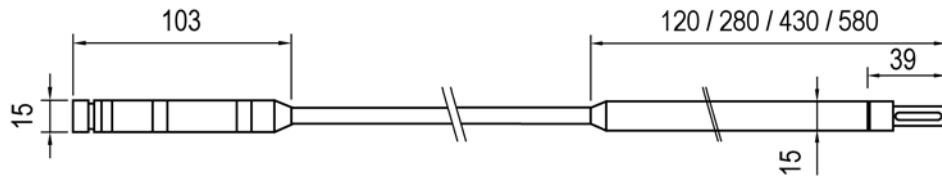

Note: HC2-IM1 (120 mm barrel length) - to avoid measurement errors due to temperature gradients fully immerse the probe barrel in the environment to be measured

E-M-HC2 Probes-V1_10	Rotronic AG Bassersdorf, Switzerland
Document code	Unit
HygroClip 2 (HC2) Humidity Temperature Probes – User Guide	Instruction Manual
	Document Type
Document title	Page 10 of 29

Measurement in compressed air conduits and vessels (fixed installation)	
<i>For use with transmitters and data loggers</i>	
HC2-IE1M02 HC2-IE1M05 HC2-IE1M10	Humidity measuring range: 0...100 %RH Temperature limits at sensor -100...200 °C (-148...392 °F) G ½" thread for maximum 400 bar / 5800 PSI Probe cable length.: 2 m (6.5 ft) or 5 m (16.4 ft) or 10 m (32.8 ft) Barrel: stainless steel Nickel plated brass filter base. Filter to be ordered separately Weight with 2 m cable: approx. 290 g (10.2 oz), + 80 g (2.8 oz) per additional meter
HC2-IE3M02 HC2-IE3M05 HC2-IE3M10	Humidity measuring range: 0...100 %RH Temperature limits at sensor -100...200 °C (-148...392 °F) NPT ½" thread for maximum 400 bar / 5800 PSI Probe cable length.: 2 m (6.5 ft) or 5 m (16.4 ft) or 10 m (32.8 ft) Barrel: stainless steel Nickel plated brass filter base. Filter to be ordered separately Weight with 2 m cable: approx. 290 g (10.2 oz), + 80 g (2.8 oz) per additional meter

Note: To avoid measurement errors, temperature should be the same on both sides of the mounting wall

E-M-HC2 Probes-V1_10	Rotronic AG Bassersdorf, Switzerland
Document code	Unit
HygroClip 2 (HC2) Humidity Temperature Probes – User Guide	Instruction Manual
	Document Type
Document title	Page 11 of 29

3 General description

3.1 Power supply

The supply voltage required by the HC2 probe depends on the probe model:

- Models with a length of cable between the sensors and electronics (HC2-IC, HC2-IM, HC2-IE, etc.):
3.3 V \pm 0.1V
- All other models: 3.2 ... 5.0 VDC (no tolerance). For these models the recommended supply voltage is 3.3 VDC as this is the voltage used by the factory to test and adjust the probe.

During start-up the HC2 probes require a higher current from the power source. Typically this current is 8 mA during 2ms and 5 mA during 2s. Without a limiter, the start-up current may reach a maximum of 50 mA. After start-up the current consumption is on average less than 3 mA with spikes of about 1 mA during 2 μ s.

The HC2 probes are polarity protected by a keyed connector. There is no electrical polarity protection.

3.2 Measured parameters

The HC2 probe measures relative humidity with a ROTRONIC Hygromer[®] IN1 capacitive sensor and temperature with a Pt100 RTD.

3.3 Calculated parameters

Using the ROTRONIC HW4 software, the HC2 probe can be configured by the user to calculate either the dew point or the frost point.

3.4 Analog output signals

The HC2 probe features two 0...1 V linear analog output signals. The default factory settings are as follows:

Output 1: 0...1 V (humidity) = 0...100 %RH
Output 2: 0...1 V (temperature) = -40...60°C

Using the ROTRONIC HW4 software any output signal can be made to correspond one of the following:

- Relative humidity
- Temperature
- Dew or frost point

Any output can also be disabled.

The scale of each analog output can be set within the numerical limits of -999.99 and 9999.99. If so desired, any output can also be disabled (no signal).

The D/A converters used to generate the analog output signals feature a 16-bit resolution. The 0...1 V analog output signals exhibit a small positive offset of 3 mV or less at 0 V.

Note: users who require an analog signal other than 0...1 V should either contact ROTRONIC or connect the probe to one of the available transmitters.

E-M-HC2 Probes-V1_10	Rotronic AG Bassersdorf, Switzerland
Document code	Unit
HygroClip 2 (HC2) Humidity Temperature Probes – User Guide	Instruction Manual
	Document Type
Document title	Page 12 of 29

3.5 Digital interface

The HC2 probe features a UART interface (Universal Asynchronous Receiver Transmitter). This type of interface requires an adapter before a connection can be made with a PC (see **Accessories > Digital interface adapters**). The probe can also be indirectly connected to a PC using an instrument from the ROTRONIC program. The UART interface allows two-way communication with the probe. Depending on the software installed on the PC (or on the type of instrument if one is used to connect the probe), the digital interface gives access to the following:

- Measurement data (humidity and temperature) and calculated parameter (dew or frost point)
- Probe information: name, RS-485 address, humidity sensor status, etc.
- Probe alarm functions
- Probe data logging function
- Probe calibration and probe adjustment functions
- Probe configuration

The ROTRONIC HW4 software (version 2.1.0 or higher) allows full access to the probe data and functions. Measured and calculated data as well as most probe functions can also be accessed with a standard communication software (see: supporting documents > E-M-HC2-Protocol).

3.6 Sensor protection (dust filter)

Most probes of the HC2 series are supplied with a filter to protect the sensors against dust particles and high air velocity. Depending on the probe model the following types of filter materials are used:

Material	Maximum temperature	Notes
Polyethylene	100 °C (212 °F)	Recommended filter material for all applications below 100 °C. Good response and good protection against fine dust particles. No water absorption or retention
Teflon	200 °C (392 °F)	Good protection against fine dust particles and salt (marine environments). Moderately slow response
Stainless steel wire mesh	200 °C (392 °F)	Provides fastest response time. Not recommended in environments with fine dust particles (clogging) and in bioactive environments
Stainless steel sintered filter	200 °C (392 °F)	Good response at low humidity levels. Do not use at high humidity levels. Provides best protection against abrasive particles

Note: Depending on the probe model, the dust filter is either automatically included with the probe or it must be ordered separately (see Models).

4 Functions

The HC2 probe features the same functions as any other device that is based on the AirChip 3000 digital technology. These functions fall into two main categories:

a) AirChip 3000 internal functions

- Temperature sensor signal conditioning
- Humidity sensor signal conditioning
- Sensor failure digital alarm

E-M-HC2 Probes-V1_10	Rotronic AG Bassersdorf, Switzerland
Document code	Unit
HygroClip 2 (HC2) Humidity Temperature Probes – User Guide	Instruction Manual
	Document Type
Document title	Page 13 of 29

b) AirChip 3000 user functions

- Psychrometric calculations [*no calculation*]
- Out-of-limit values [*disabled*]
- Simulator mode [*disabled*]
- Automatic humidity sensor test and drift compensation [*disabled*]
- Sensor failure mode [*disabled*]
- Data recording [*off*]
- Humidity-temperature calibration and adjustment

Notes:

- Where relevant, the function factory default is indicated in italics
- For a general description of all AirChip 3000 functions see document **E-T-AC3000-DF-V1**
- Enabling, configuring and using the AirChip 3000 user functions requires a PC with the HW4 software installed (version 2.1.0 or higher). See **Accessories > Digital interface adapters** for the cable to connect the HC2 probe to the PC. Instructions are provided in the HW4 manuals: **E-M-HW4v2.1-Main**, **E-M-HW4v2.1-F2-001**, **E-M-HW4v2.1-DR-001** and **E-M-HW4v2.1-A2-001**.

5 User configurable settings

Configuration of the HC2 probe by the user requires a PC with the ROTRONIC HW4 software (version 2.1.0 or higher) installed and a cable to connect the HC2 probe to the PC (see **Accessories > Digital interface adapters**). The following settings can be configured with the HW4 software:

Configurable Setting	Factory default
Output 1 parameter, scale and unit	Relative humidity: 0...100 %RH
Output 2 parameter, scale and unit	Temperature: -40...60 °C
Trend indicator	Enabled
RS-485 address	0
Device name	Probe type
Device write protection	Disabled

Instructions for configuring the HC2 probe are provided in the HW4 manual **E-M-HW4v2.1-F2-001**.

6 Mechanical installation

Note: the following instructions apply only to the situation where the HC2 probe is fixed installed.

6.1 General guidelines for fixed installation

For best results, please observe the following guidelines:

Install the probe at a location where humidity, temperature and pressure conditions are representative of the environment or process to be measured. Avoid the following: (a) Close proximity of the probe to a heating element, a cooling coil, a cold or hot wall, direct exposure to sun rays, etc. (b) Close proximity of the probe to a steam injector, humidifier, direct exposure to precipitation, etc. (c) Unstable pressure conditions resulting from excessive air turbulence.

When installing the probe on a wall, do not place the probe right above a heat producing device of instrument such as a transmitter or an Ethernet adapter (warm air tends to rise).

If possible, choose a location that provides good air movement at the probe: air velocity of at least 1 meter/second (200 ft/ minute) facilitates adaptation of the probe to changing temperature.

E-M-HC2 Probes-V1_10	Rotronic AG Bassersdorf, Switzerland
Document code	Unit
HygroClip 2 (HC2) Humidity Temperature Probes – User Guide	Instruction Manual
Document title	Document Type
	Page 14 of 29

When installing the probe through a wall, immerse as much of the probe as possible in the environment to be measured.

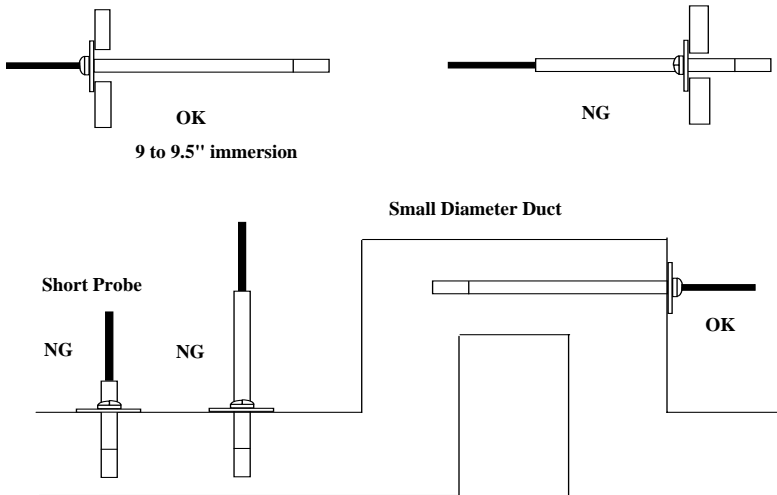

Position the probe so as to prevent the accumulation of condensation water at the level of the sensor leads. Install the probe so that the probe tip is looking downward. If this is not possible, install the probe horizontally.

Depending on the probe model, a probe holder (mounting flange with a compression fitting) can facilitate installation through a wall.

Future maintenance can be made easier by providing next to the probe a calibration access orifice. During maintenance, this permits the insertion of a reference probe (calibrator). The calibration access orifice should have the same size as the orifice used to install the probe and can be equipped with a probe holder.

7 Electrical installation

Note: the following instructions apply only to the situation where the HC2 probe is fixed installed.

7.1 General guidelines for fixed installation

Power supply wiring

Heavy machinery and instrumentation should not share the same power supply wiring. If this cannot be avoided, noise filters and surge protectors should be used. Most UPS devices have those features already integrated.

General guidelines for signal cables

The following guidelines are derived from European Standard EN 50170 for the transmission of signals by copper wires. When planning an installation, the rules provided by EN 50170 should be followed under consideration of local circumstances to determine the position of machines and equipment.

E-M-HC2 Probes-V1_10	Rotronic AG Bassersdorf, Switzerland
Document code	Unit
HygroClip 2 (HC2) Humidity Temperature Probes – User Guide	Instruction Manual
	Document Type
Document title	Page 15 of 29

All ROTRONIC HygroClip products are tested for Electromagnetic Compatibility according to EMC Directive 2004/106/EG and following European standards:

- EN 61000-6-1: 2001, EN 61000-6-2: 2005
- EN 61000-6-3: 2005, EN 61000-6-4: 2001 + A11

Whenever the level of electromagnetic interference is expected to be high, both the instruments and signal cables should be placed as far away as possible from the source of interference.

In general, signal cables should be installed in bundles or channels / conduits, separate from other cables as indicated in the table below:

<ul style="list-style-type: none"> • Bus signals such as RS485 • Data signals for PCs, printers etc. • shielded analog inputs • unshielded direct current (<= 60V) • shielded process signals (<= 25 V) • unshielded alternate current (<= 25V) • coaxial cables for CRT monitors 	in common bundles or channels / conduits
<ul style="list-style-type: none"> • direct current from 60 V to 400 V (unshielded) • alternate current from 25V to 400 V (unshielded) 	in separated bundles or channels / conduits, without minimum distance
<ul style="list-style-type: none"> • direct and alternate current > 400 V (unshielded) • Telephone lines • lines leading into EX-rated areas 	in separated bundles or channels / conduits, without minimum distance

Lightning protection

Cabling in areas with a risk of lightning requires a lightning protection. For cabling underground in between buildings, we recommend the use of special fiber optic cables. If this is not possible, use copper cables that are suitable for underground installation.

7.2 Connector

All standard probe models of the HC2 series use the same keyed connector (male). The connector is either directly on the probe body or at the end of a cable. The probe connector is secured to the matching female connector with a threaded collar.

E-M-HC2 Probes-V1_10	Rotronic AG Bassersdorf, Switzerland
Document code	Unit
HygroClip 2 (HC2) Humidity Temperature Probes – User Guide	Instruction Manual
	Document Type
Document title	Page 16 of 29

Pin-out diagram

Probe connector (7-pin male – looking at probe)

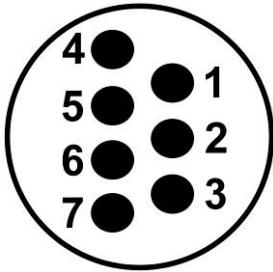

Pin #	Name	Function
1	VDD (+)	3.2 to 5 VDC
2	GND	Power and digital signal
3	RXD	UART
4	TXD	UART
5	Out 1 analog (+)	Humidity 0...100%RH (default)
6	Out 2 analog (+)	Temperature -40...60°C (default)
7	AGND	Analog signal ground

7.3 Wiring color code

The following color code applies to the E2-XX panel mount connector and to cables terminated with tinned wires (see Accessories).

Wire color	Name	Function
Green	VDD (+)	3.2 to 5 VDC, except cables with built-in voltage adapter (see Accessories)
Grey	GND	Power and digital signal
Red	RXD	UART
Blue	TXD	UART
White	Out 1 analog (+)	Humidity 0...100%RH (default) or calculated parameter
Brown	Out 2 analog (+)	Temperature -40...60°C (default)
Yellow	AGND (-)	Analog signal ground

Shielded cables with tinned ends: the shield is ended as a non-insulated wire connected to GND at the connector level

7.4 Analog signal wiring

Preferably use a shielded cable to connect the analog outputs of the HC2 to other devices. The maximum cable length is determined by the maximum error that the user will accept. This can be calculated as follows:

Error (V) = cable resistance x current through load

7.5 Minimum analog output load

The HC2 analog outputs are short circuit tolerant and have an internal resistance of less than 10 Ω. For proper operation, the minimum external load of each output should be at least 1000 Ω.

E-M-HC2 Probes-V1_10	Rotronic AG Bassersdorf, Switzerland
Document code	Unit
HygroClip 2 (HC2) Humidity Temperature Probes – User Guide	Instruction Manual
	Document Type
Document title	Page 17 of 29

7.6 *Digital signal wiring*

Use one of the available connecting cables (see Accessories) to connect the UART digital interface of the HC2 probe to other devices. Without a signal booster, the maximum cable length should not exceed 5 m (16 ft).

7.7 *Grounding*

In the case of a fixed installation, ground the HC2 probe, especially if the electronics will be subjected to a low humidity environment (35 %RH or less). The power supply and digital ground (GND) and the analog ground (AGND) should be tied separately to a proper ground so as to avoid spikes in the analog signals.

8 *Operation*

8.1 *Operation with an indicator, data logger or transmitter*

The HC2 probes are compatible with a large number of indicators, data loggers and transmitters from ROTRONIC. Operating instructions are provided in each device manual.

8.2 *Analog probe operation (stand-alone)*

The HC2 probes can be used as a stand-alone conventional analog probe. See Accessories > Connectors and cables for OEM applications. Use the HW4 software to configure the probe as desired, complete the mechanical and electrical installation and power up the probe.

8.3 *PC or network operation*

The HC2 probes can be directly connected to a PC or to an Ethernet network with one of the available digital interface adapters (see Accessories). Probe configuration and full access to all probe functions requires a PC with the ROTRONIC HW4 software installed. Users who do not wish to use the HW4 software can communicate with the probe and access most functions with the HygroClip 2 communication protocol commands (see: supporting documents).

8.4 *Hand-held probes*

The most common source of error when measuring relative humidity with a hand-held probe is a difference between the temperature of the probe and the temperature of the environment. At a humidity condition of 50 %RH, a temperature difference of 1°C (1.8 °F) typically results in an error of 3 %RH on relative humidity.

When using a humidity probe with a portable indicator, it is good practice to monitor the display for temperature stability. When moving the probe from one area to another, the probe should be given sufficient time to equilibrate with the environment to be measured. This time can be shortened, and errors avoided, by using the probe configuration that fits best for your application.

In extreme situations, condensation may occur on the sensors when the probe is colder than the environment. As long as the humidity / temperature limits of the humidity sensor are not exceeded, condensation does not alter the calibration of the sensor. However, the sensor has to dry out before it can provide a valid measurement.

Non-moving air is an excellent insulator. When there is no air movement, surprising differences in temperature and humidity can be noted over short distances. Air movement at the probe generally results in measurements that are both faster and more accurate.

E-M-HC2 Probes-V1_10	Rotronic AG Bassersdorf, Switzerland
Document code	Unit
HygroClip 2 (HC2) Humidity Temperature Probes – User Guide	Instruction Manual
	Document Type
Document title	Page 18 of 29

9 Maintenance

9.1 *Cleaning or replacing the dust filter*

Depending on the conditions of measurement, the filter should be checked from time to time. Corroded, discolored or clogged filters should be replaced.

- If the probe has a removable cartridge, simply replace the cartridge (leave the metal base on the probe).



- If the probe has a plastic slotted cap with a built-in filter element follow these instructions:
 - 1) Unscrew the filter from the probe and pull it straight away, in the alignment of the probe, so as not to catch the humidity and temperature sensors.
 - 2) Before putting on a new dust filter, check the alignment of both sensors with the probe. The wires that connect the sensors to the probe are very thin and bend easily. If necessary, correct the alignment by tapping the sensor very gently with a smooth object such as a small plastic rod. Do not use sharp pliers or tweezers as this could puncture the sensor and do not pull hard on the sensor.

9.2 *Periodic calibration check*

Both the Pt 100 RTD temperature sensor and associated electronics are very stable and should not require any calibration after the initial factory adjustment.

Long term stability of the ROTRONIC Hygromer humidity sensor is typically better than 1 %RH per year. For maximum accuracy, calibration of the probe should be verified every 6 to 12 months. Applications where the probe is exposed to contaminants may require more frequent verifications. Calibration and adjustment of the HC2 probe can be done with either a PC with the HW4 software installed (version 2.1.0 or higher) or with the HP23 hand-held calibrator. For connecting the HC2 probe to a PC, see **Accessories > Digital Interface Adapters**.

Procedure for adjusting the HC2 probe with the ROTRONIC HW4 software:

- Connect the HC2 probe to the HW4 PC as explained in the HW4 manual **E-M-HW4v2.1-Main**
- Start HW4 software on the PC and search for the HC2 probe. (HW4 Main Menu Bar > Devices and Groups > Search for USB masters or Search for RS232 masters or search for Ethernet masters, depending on the connecting cable).
- After finding the HC2 probe with HW4, expand the device tree to see the HC2 probe functions and select **Probe Adjustment**.
- For further instructions see HW4 manual **E-M-HW4v2.1-A2-001**

9.3 *Validation of the output signals transmission*

If so desired, transmission of the HC2 probe output signals can be validated by using the probe simulator function. The HW4 software is required to enable and configure this function. When the function is enabled the probe generates digital and analog signals corresponding to values specified by the user.

E-M-HC2 Probes-V1_10 <small>Document code</small>	Rotronic AG Bassersdorf, Switzerland <small>Unit</small>
HygroClip 2 (HC2) Humidity Temperature Probes – User Guide <small>Document title</small>	<div style="text-align: right;"> Instruction Manual <small>Document Type</small> </div> <hr/> <div style="text-align: right;"> Page 19 of 29 </div>

10 Firmware updates

Firmware updates will be available on the ROTRONIC website for downloading. Firmware files are given a name that shows both to which device the file applies and the version number of the firmware. All firmware files have the extension HEX. For connecting the HC2 probe to a PC, see **Accessories > Digital Interface Adapters**.

Procedure for updating the firmware:

- Connect the HC2 probe to the HW4 PC as explained in the HW4 manual **E-M-HW4v2.1-Main**
- Copy the firmware update file from the ROTRONIC website to the PC.
- Start HW4 software on the PC and search for the HC2 probe. (HW4 Main Menu Bar > Devices and Groups > Search for USB masters or Search for RS232 masters or search for Ethernet masters, depending on the connecting cable).
- After finding the HC2 probe, expand the device tree to see the HC2 probe functions. Select Device Manager. In the Device Manager menu bar select Tools > Firmware Update. For instructions see document **E-M-HW4v2.1-F2-001**

E-M-HC2 Probes-V1_10	Rotronic AG Bassersdorf, Switzerland
Document code	Unit
HygroClip 2 (HC2) Humidity Temperature Probes – User Guide	Instruction Manual
Document title	Document Type
	Page 20 of 29

11 Technical data

11.1 Specifications

General	
Device type	Humidity temperature probe
Mechanical configuration	See models

Power supply and connections	
Supply voltage (VDD)	HC2-IC, HC2-IM and HC2-IE: 3.3 V ± 0.1V All other models: 3.2 ... 5.0 VDC ± 0%
Recommended supply voltage	3.3 VDC
Supply voltage during factory tests and adjustment	3.3 VDC
Supply voltage stability / ripple	See System Accuracy, effect of VDD
Nominal current consumption	< 4.5 mA at VDD = 3.3 VDC 7.5 mA at VDD = 5 VDC
Maximum start-up current unlimited	< 50mA during 2µs
Minimum start-up current required	Typical: 8 mA during 2ms and 5 mA during 2s
Maximum current spike during operation	1 mA during maximum 2µs
Polarity protection	Mechanical only (keyed connector)

Humidity measurement	
Sensor	ROTRONIC Hygromer® IN1
Measuring range	0...100 %RH
Measurement accuracy at 23 °C	±0.8 %RH (w. standard adjustment profile)
Repeatability	0.3 %RH
Long term stability	< 1 %RH / year
Sensor time constant	Typical 10 sec, 63% of a 35 to 80 %RH step change (1m/sec air flow at sensor)

Temperature measurement	
Sensor	Pt100 RTD, IEC 751 1/3 class B
Measuring range	-100...200 °C (see also environmental limits)
Measurement accuracy at 23 °C	±0.1 °C
Repeatability	0.05°C
Long term stability	< 0.1°C / year
Sensor time constant	Typical 4 sec, 63% of a step change (1m/sec air flow at sensor)

Calculated parameters	
Psychrometric calculations	Dew or frost point (user configurable)

Start-up time and data refresh rate	
Start-up time	1.5s (typical)
Data refresh rate	1.0s (typical) – when not calculating any parameter

E-M-HC2 Probes-V1_10	Rotronic AG Bassersdorf, Switzerland
Document code	Unit
HygroClip 2 (HC2) Humidity Temperature Probes – User Guide	Instruction Manual
Document title	Document Type
	Page 21 of 29

Configurable analog outputs	
Output 1	Can be made to correspond to any parameter
Factory default parameter	Relative humidity
Factory default scale	0...100 %RH
Output 2	Can be made to correspond to any parameter
Factory default parameter	Temperature
Factory default scale	-40...60 °C
Output 1 and Output 2	
Signal type	0...1 V
User configurable scaling limits	-999.99 ... 9999.99 engineering units
Offset at 0 V	+ 3 mV (maximum)
Ripple	< 1.2 mV/x 2µs
Short circuit tolerant	Yes
Internal resistance	< 10 Ω
Minimum external load	1000 Ω
Deviation from digital signal	< ±1 mV from 0.002 to 1.0 V / + 2 mV from 0.0 to 0.002 V

Digital interface	
Interface type	UART (Universal Asynchronous Receiver Transmitter)
Organization	Dialog, duplex
Default configuration	Baud rate : 19200 Parity : none Data bits : 8 Stop bits : 1 Flow Control : none
Tolerance	3 %
Baud rate configuration:	No
Logical levels	Logical 0: <= 0.3V * VDD Logical 1: >= 0.8V * VDD
Maximum cable length	5 m (16.4 ft) w/o signal booster

Effect of VDD in the range 3.2 to 5.0 V (see note below)	
Temperature (digital)	<0.05 °C
Humidity (digital)	<0.25 %RH
Analog signals	<2mV (reference: digital value)

Note: for models HC2-IC, HC2-IM and HC2-IE, VDD is limited to 3.3 V ± 0.1V

General specifications	
Housing material	Polycarbonate
Collar material (connector)	Alu-Anticorodal (anodized)
Dust filter material	See Models
Protection grade	IP 65
Physical dimensions	See Models
Weight	See Models

E-M-HC2 Probes-V1_10	Rotronic AG Bassersdorf, Switzerland
Document code	Unit
HygroClip 2 (HC2) Humidity Temperature Probes – User Guide	Instruction Manual
	Document Type
Document title	Page 22 of 29

Conformity to standards	
CE / EMC immunity	EMC Directive 2004/108/EG: EN 61000-6-1: 2001, EN 61000-6-2: 2005 EN 61000-6-3: 2005, EN 61000-6-4: 2001 + A11
Solder type	Lead free (RoHS directive)
FDA / GAMP directives	compatible

Environmental limits	
Storage and transit	-50...+100 °C / 0...100 %RH, non condensing
Operating limits at electronics	-40 ... +100 °C 0...100 %RH, non condensing
Temperature limits at sensor	See Models
Maximum humidity at sensor	100 %RH up to 80 °C (176 °F) 75 %RH at 100 °C (212 °F) 45 %RH at 125 °C (260 °F) 15 %RH at 150 °C (302 °F)
Maximum air velocity at probe	20 m/s (3,935 ft /min)
Critical environments	Humidity sensor: as per DV04-14.0803.02 - Critical chemicals

11.2 Dew point accuracy

The HC2 probes can be configured to calculate either the dew point or frost point based on the measurement of relative humidity and temperature. The accuracy of this conversion varies, depending on the humidity and temperature conditions as shown in the graph below:

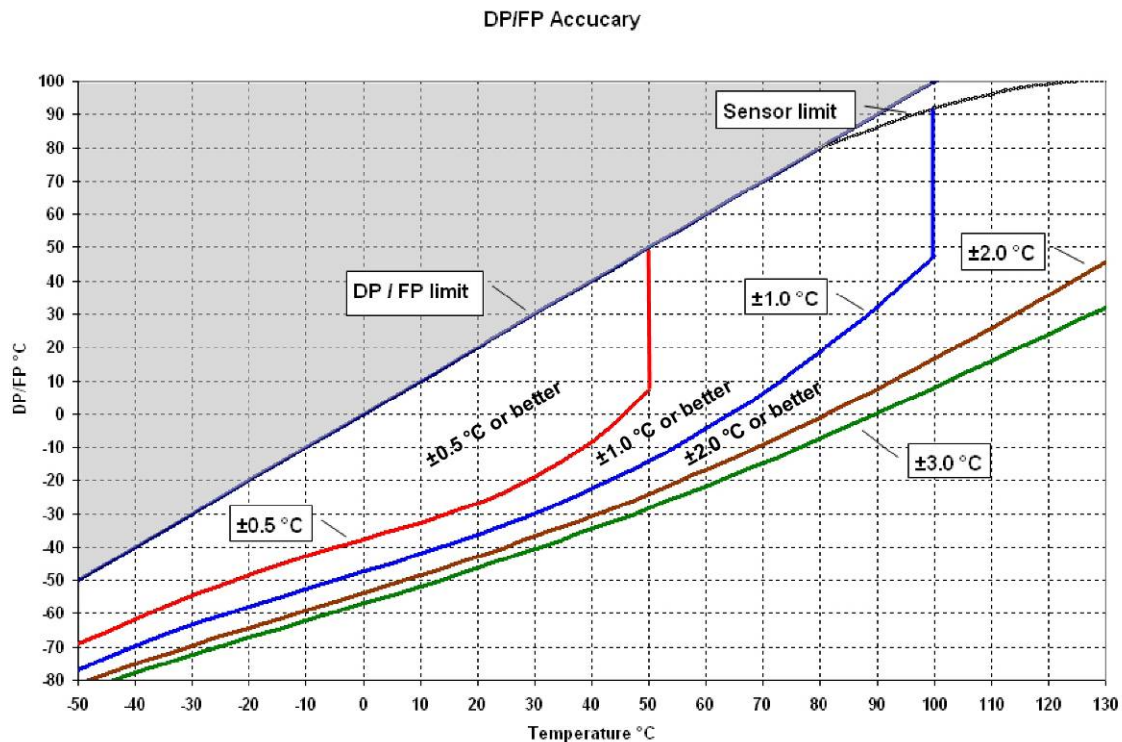

Example: at a temperature of 20 °C, a dew point value of -37 °C is measured with an accuracy of ± 1.0 °C or better.

E-M-HC2 Probes-V1_10	Rotronic AG Bassersdorf, Switzerland
Document code	Unit
HygroClip 2 (HC2) Humidity Temperature Probes – User Guide	Instruction Manual
	Document Type
Document title	Page 23 of 29

12 Accessories

12.1 Configuration and communication software

The ROTRONIC HW4 software (version 2.1.0 or higher) allows configuring the HC2 probes and offers additional functionality such as:

- Networking (unlimited number of masters, up to 64 units per multi-drop)
- Data logging to a PC disk file
- Graphic functions (both on and off-line)
- Alarm functions (on-screen display, reports, notification by e-mail, etc.)

HW4 is compatible with Windows XP, Vista and NT4 with SP6a or higher. For more details see separate instruction manual provided with the software.

Order Code	Description
HW4-E	HW4 software, Standard Edition (single user)
HW4-P	HW4 Professional Edition, ERES regulations compliant (FDA / GAMP), multi user

12.2 Passive extension cables

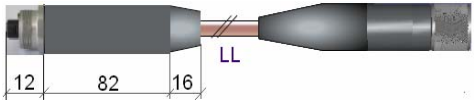
Order Code	Description	
E2-F3A	0.3 m (1 ft) extension cable (black) HC2 to instrument with standard 7-pin female / male connectors and wall mounting bracket for the HC2-S probe	Schematic illustrations only!
E3-F3A	Same as E2-F3A with white cable. Use with the HC2-S3 probe	
E2-01A	1 m (3.2 ft) extension cable (black) HC2 to instrument with standard 7-pin female / male connectors. Barrel length 82 mm (3.2")	
E3-01A	Same as E2-01A with white cable	
E2-02A	2 m (6.5 ft) extension cable (black) HC2 to instrument with standard 7-pin female / male connectors	
E3-02A	Same as E2-02A with white cable	
E2-05A	5 m (16.4 ft) extension cable (black) HC2 to instrument with standard 7-pin female / male connectors	
E3-05A	Same as E2-05A with white cable	

12.3 Extension cables with digital signal booster

E-M-HC2 Probes-V1_10	Rotronic AG Bassersdorf, Switzerland
Document code	Unit
HygroClip 2 (HC2) Humidity Temperature Probes – User Guide	Instruction Manual
	Document Type
Document title	Page 24 of 29

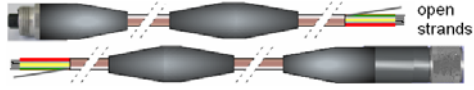
Order Code	Description
AC3003	Active UART Booster set Connects HC2 probe to a transmitter. Up to 100 m (328 ft) cable length Tinned ends
	 <p>See Installation > Wiring color code</p>

12.4 Digital interface adapters

Order Code	Description
AC3001	UART to USB adapter cable Connects HC2 probe to PC running HW4
AC3002	UART to RS232 adapter cable Connects HC2 probe to PC running HW4
AC3005	UART to Ethernet (TCP/IP) adapter cable Connects HC2 probes to Ethernet network

IMPORTANT:

- Prior to using cable AC3001, the ROTRONIC USB driver must be installed on the PC. Both the driver and the installation instructions (document **E-M-HW4v2.1-Main**) are located on the HW4 CD.
- Prior to using cable AC3005, the TCP/IP settings of the cable must be configured by the user to be compatible with the local area network. Detailed instructions are provided separately in documents **E-M-HW4v2.1-Main** and **IN-E-TCPIP-Conf**. Devices with an Ethernet interface are shipped with a Device Configuration Certificate that provides information about the factory configuration settings.

12.5 Connectors and passive cables for OEM applications

Order Code	Description
E2-XX	Female connector for panel mount with 7 wires (0.3 m / 1ft), tinned ends
	 <p>See Installation > Wiring color code</p>

E-M-HC2 Probes-V1_10	Rotronic AG Bassersdorf, Switzerland
Document code	Unit
HygroClip 2 (HC2) Humidity Temperature Probes – User Guide	Instruction Manual
Document title	Document Type
	Page 25 of 29

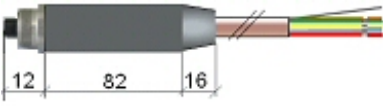
Order Code	Description	
E2-01XX	Female connector (black), 1 m (3.2 ft) cable with tinned ends	 <p>See Installation > Wiring color code</p>
E2-02XX	Same as E2-01XX with 2m (6.5 ft) cable	
E2-05XX	Same as E2-01XX with 5m (16.4 ft) cable	
E3-01XX	Female connector (white), 1 m (3.2 ft) cable with tinned ends	
E3-02XX	Same as E3-01XX with 2m (6.5 ft) cable	
E3-05XX	Same as E2-01XX with 5m (16.4 ft) cable	
E2-02AS	Same as E2-02A, but with short barrel	
E3-02AS	Same as E3-02A, but with short barrel	

12.6 Cables with built-in voltage adapter for OEM applications

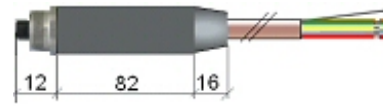
Order Code	Description	
E2-01XX-ACT	Female connector (black) with built-in voltage regulator for HC2 probes. Supply voltage 8...40 VDC / 6...28 VAC 1 m (3.2 ft) cable with tinned ends	 <p>See Installation > Wiring color code</p>
E2-02XX-ACT	Same as E2-01XX-ACT with 2m (6.5 ft) cable	
E2-05XX-ACT	Same as E2-01XX-ACT with 5m (16.4 ft) cable	
E3-01XX-ACT	Female connector (white) with built-in voltage regulator for HC2 probes. Supply voltage 8...40 VDC / 6...28 VAC 1 m (3.2 ft) cable with tinned ends	
E3-02XX-ACT	Same as E3-01XX-ACT with 2m (6.5 ft) cable	
E3-05XX-ACT	Same as E3-01XX-ACT with 5m (16.4 ft) cable	

E-M-HC2 Probes-V1_10	Rotronic AG Bassersdorf, Switzerland
Document code	Unit
HygroClip 2 (HC2) Humidity Temperature Probes – User Guide	Instruction Manual
	Document Type
Document title	Page 26 of 29

12.7 Mounting hardware



Order Code	Description	
AC1303-M	Compression fitting for 25 mm (1.0") diameter probes. Maximum temperature 200 °C (392°F)	
AC1304-M	Compression fitting for 15 mm (0.6") diameter probes. Maximum temperature 200 °C (392°F)	
AC1305	Flange for AC1303-M – nickel coated steel Diameter: 80 mm (3.1")	
AC1306	Flange for AC1304-M – nickel coated steel Diameter: 80 mm (3.1")	

12.8 Calibration accessories



Order Code	Description
EA00-SCS	0.5 %RH humidity std, SCS cert., pack of 5
EA05-SCS	5 %RH humidity std, SCS cert., pack of 5
EA10-SCS	10 %RH humidity std, SCS cert., pack of 5
EA20-SCS	20 %RH humidity std, SCS cert., pack of 5
EA35-SCS	35 %RH humidity std, SCS cert., pack of 5
EA50-SCS	50 %RH humidity std, SCS cert., pack of 5
EA65-SCS	65 %RH humidity std, SCS cert., pack of 5
EA80-SCS	80 %RH humidity std, SCS cert., pack of 5
EA95-SCS	95 %RH humidity std, SCS cert., pack of 5
ER-15	Calibration device for 15mm diameter probes
ER-05	Calibration device for 5mm diameter probes
EM-G	Calibration device for type 'IE' probes



For instructions regarding the ROTRONIC humidity standards and calibration devices see document **E-M-CalBasics**.

12.9 Dust filters

Order Code	Probe	Slotted cap	Filter insert	
NSP-PCB-PE	HC2-S	Polycarbonate, black	Polyethylene	
NSP-PCB-WM			Wire mesh	
NSP-PCB-TF			Teflon	
NSP-PCW-PE	HC2-S3	Polycarbonate, white	Polyethylene	
NSP-PCW-WM			Wire mesh	
NSP-PCW-TF			Teflon	

E-M-HC2 Probes-V1_10	Rotronic AG Bassersdorf, Switzerland
Document code	Unit
HygroClip 2 (HC2) Humidity Temperature Probes – User Guide	Instruction Manual
	Document Type
Document title	Page 27 of 29

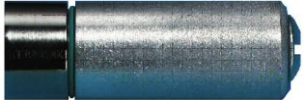



Order Code	Probe	Filter Base	Filter Cartridge	
NSP-ME-WM	HC2-IC probes	Nickel plated brass filter base HC2 thread	Wire mesh	
NSP-ME-SS	HC2-IC probes	Nickel plated brass filter base HC2 thread	Steel sinter	
NSP-ME-TF	HC2-IC probes	Nickel plated brass filter base HC2 thread	Teflon	

Order Code	Probe	Filter Base	Filter Cartridge	
SP-MC15	HC2-IM and HC2-IE probes	Nickel plated brass filter base HC1 thread	Wire mesh	
SP-SC15	HC2-IM and HC2-IE probes	Nickel plated brass filter base HC1 thread	Steel sinter	
SP-TC15	HC2-IM and HC2-IE probes	Nickel plated brass filter base HC1 thread	Teflon	

Order Code	Probe	Description	
SP-T05	H2C-C05	Teflon filter	

E-M-HC2 Probes-V1_10	Rotronic AG Bassersdorf, Switzerland
Document code	Unit
HygroClip 2 (HC2) Humidity Temperature Probes – User Guide	Instruction Manual
	Document Type
Document title	Page 28 of 29

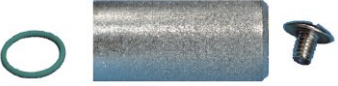
12.10 Filter spare parts

Order Code	Probe	Description	
NSP-ME	HC2-IC probes	Filter base Nickel plated brass HC2 thread Filter Cartridge not included	
SP-MSB15	HC2-IM and HC2-IE probes	Filter base Nickel plated brass HC1 thread Filter Cartridge not included	
SP-M15	HC2-IC HC2-IM and HC2-IE probes	Wire mesh filter cartridge Use with NSP-ME or SP-MSB15	
SP-S15	HC2-IC HC2-IM and HC2-IE probes	Sintered steel filter cartridge Use with NSP-ME or SP-MSB15	
SP-T15	HC2-IC HC2-IM and HC2-IE probes	Teflon filter cartridge Use with NSP-ME or SP-MSB15	

E-M-HC2 Probes-V1_10 Document code	Rotronic AG Bassersdorf, Switzerland Unit
HygroClip 2 (HC2) Humidity Temperature Probes – User Guide Document title	Instruction Manual Document Type Page 29 of 29

13 Supporting documents

Document File Name	Contents
E-T-AC3000-DF-V1	AirChip 3000 Description and Main Functions
E-M-HW4v2.1-DIR	List of the HW4 manuals
E-M-HW4v2.1-Main	HW4 software version 2.1: General instructions and functions common to all devices
E-M-HW4v2.1-F2-001	HW4 software version 2.1: HC2 probe series Device configuration and AirChip 3000 functions
E-M-HW4v2.1-A2-001	HW4 software version 2.1: Probe Adjustment function AirChip 3000 devices
E-M-HW4v2.1-DR-001	HW4 software version 2.1: Data Recording Function AirChip 3000 Devices
E-M-AC3000-CP	AirChip 3000 Communication Protocol
IN-E-TCPIP-Conf	Configuration procedures for ROTRONIC devices with Ethernet (TCP/IP) interface
E-M-CalBasics	Temperature and humidity adjustment basics Instructions for using the ROTRONIC humidity standards
E-T-HumiDefs	Humidity Definitions
DV04-14.0803.02	Critical chemicals
E-T-HC2-Equivalence	Product equivalence with previous models

Note: All document file names have an extension corresponding to the document release number (example of a first release: E-M-HW4v2.1-Main_10). This extension is not shown in the above table.

14 Document releases

Doc. Release	Date	Notes
_10	Jun. 27, 2008	Original release