

FTCST-A4P-2ARX/115VAC

Freely Rotatable FTCST Flow Sensor – Monitoring of Flow Speed and Medium Temperature

Relay Output 115 VAC NO

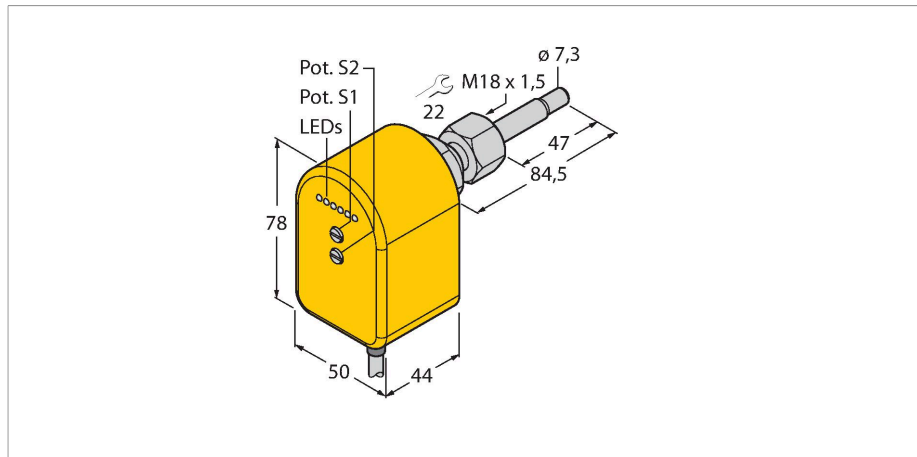

Features

- Thermodynamic operating principle
- Flow monitoring
- Monitoring of medium temperature
- Switchpoints freely adjustable
- Adjusted via potentiometer
- LED band for indications
- 2 relay switching outputs
- 115 VAC NO
- Switchpoints freely adjustable
- Freely rotatable sensor
- Plugged in with adapter
- Screw-in adapter, M18 x 1.5

Technical data

ID	6870281
Type	FTCST-A4P-2ARX/115VAC
Mounting conditions	Immersion sensor
Water Operating Range	1...150 cm/s
Oil Operating Range	3...300 cm/s
Stand-by time	typ. 8 s (2...15 s)
Switch-on time	typ. 2 s (1...13 s)
Temperature gradient	≤ 250 K/min
Medium temperature	-20...+80 °C
Ambient temperature	-20...+70 °C
Electrical data	
Operating voltage	104...126 VAC
Current consumption	≤ 65 mA
Output function	Relay output, 2 normally open contact
AC switching current	4 A
DC switching current	4 A
AC switching voltage	250 VAC
DC switching voltage	60 VDC
Max. AC switching capacity	1000 VA
Max. DC switching capacity	60 W
Protection class	IP65
Mechanical data	
Design	Immersion
Housing material	Plastic, PBT

Wiring diagram

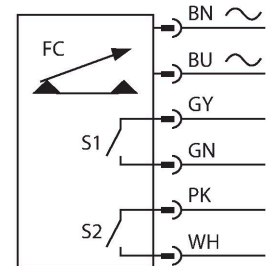

Functional principle

The FTCST flow sensors operate on the thermodynamic principle. In addition to the flow velocity, they also monitor the medium temperature.

Thanks to the modular plug-in concept, they can be aligned freely within the flow channel, independent from the process connection. The modular concept makes installation and precise alignment of the sensor easy which is very important for flow monitoring.

The adapters are available in all standard industrial thread sizes. The sensor-adapter system can thus be adjusted easily to any application requirements. The modular concept makes the system also very resistant to high pressures.

Especially flow sensors with integrated signal processor profit from the modular FTCST concept. Thanks to the freely alignable sensor, the LED display is always easy to read and the potentiometers for the adjustment of the switchpoint or analog signal are always within reach.

Technical data

Sensor material	Stainless steel, 1.4571 (AISI 316Ti)
Seal	FPM
Electrical connection	Cable
Cable length	2 m
Cable Jacket Material	PVC
Core cross-section	6 x 0.5 mm ²
Pressure resistance	100 bar
Process connection	M18 × 1.5 female thread
Tests/approvals	
Approvals	cULus
UL registration number	E210608

LED display

LED	Color	Status	Description
LED 1	red	on	The flow has failed or dropped below the default setpoint. Switching output 1 is not switched.
LED 2	yellow	on	The setpoint is reached. Switching output 1 is switched.
LED 3 ... 6	green	on	The adjusted setpoint is exceeded. The number of illuminated LEDs is a measure of the relative exceedance of the setpoint. Switching output 1 is switched.
LED Temp	red	on	The default value of the medium temperature is reached or exceeded. Switching output 2 is switched.

Mounting instructions

Mounting Adapter	<p>The freely rotatable flow sensors are mounted with the FCA-FCST adapter. The adapter is screwed in a T piece or a welding sleeve and sealed accordingly. When assembling adapters with cylindrical thread, use the enclosed seal (e.g. G1/4, G1/2, G3/4, etc.). Mounting adapters with NPT-thread are generally delivered without seal (e.g. N1/2). Use hemp or teflon tape</p> <p>The sensor is fixed in the adapter by means of a captive nut fitted between the upper housing part and the cone seat.</p>
Mounting position	<p>In order to minimize potential misinterpretations due to disturbance, it is recommended to position the sensor with a minimum separation distance of $3 \times d_i$ before and $5 \times d_i$ after bends, changes in cross section, valves, etc..</p> <ul style="list-style-type: none"> ■ If the flow channel is not completely filled with the medium, it is recommended to install the sensor from underneath. ■ If deposits are likely to built up, it is recommended to install the sensor on the side. It is important to note that deposits can also form on the tip, which may affect the monitoring results. Therefore, it is recommended to clean the sensor at regular intervals and to select the associated service interval accordingly. ■ If blistering is to be expected, ensure that there is no air bubble located in the area of the tip when installing the sensor. ■ If the sensor is mounted in vertical piping systems, it is recommended to position the sensor within the riser.
Correct installation	<p>To retrieve the full performance potential of the sensor, it must be aligned correctly. In particular when monitoring bad heat-conductive media such as oils, liquids with high solids, abrasive media, etc., when exposed to fast temperature changes (K/min) and, in general, near components with analog output.</p> <p>Correct installation is ensured, as soon as the effective flow direction of the application matches the direction of flow indicated by the "arrow" on the sensor.</p>

Adjustment guidelines

Switching outputs	Setup with resting medium	<ul style="list-style-type: none"> ■ Install sensor in the flow channel, switch on the device and wait for standby time. ■ Set the potentiometer S1 so that the red LED just turns on. In the case of two switching outputs also valid for S2. ■ When the medium starts to flow, at least one green LED should be on.
	Setup with flowing medium	<ul style="list-style-type: none"> ■ Install sensor in the flow channel, set flow and turn on the device. Wait for standby time. ■ Set potentiometer S1 so that one or two green LEDs are on. In the case of two switching outputs also valid for S2. ■ When the medium stops flowing, the red LED must turn on.
	Temperature setup	Potentiometer S2 to set the value of the medium temperature. Setting range 0 ... 80 °C.