

- Internal memory for 30 inspections
- 1/3" CMOS, 752x480 pixels
- Integrated ring light: red
- Protection class IP67
- External strobe output + 5 VDC
- External trigger input
- Lens, 6mm, M12x1
- Ethernet IP data communication, M8 male connector, 4-pole
- 3 x parameterizable switching output
- Operating voltage: 10...30 VDC
- USB 2.0 host: M8 female connector, 4-pole
- External strobe output: +5 VDC
- External display RD35 required

Type code	IVUPRBR06
Ident no.	3016322

<b>Design</b>	rectangular, iVu PLUS
Dimensions	51.5 x 81.2 x 95.3 mm
Housing material	plastic, PBT
Window material	Acrylic, clear
Connection	male, M12 x 1, 12-wire
Protection class	IP67
Ambient temperature	0...+50 °C

<b>Power on display</b>	LED, green
Switching state	LED green
Error indication	LED red

<b>Operating voltage</b>	10...30VDC
DC rated operational current	≤ 850 mA
Short-circuit protection	yes/ cyclic
Reverse polarity protection	yes
Switch element function	programmable, PNP/NPN
Output current	≥ 150 mA

<b>Operating mode</b>	BCR
Auflösung	752 x 480 Pixel
Bildfrequenz	100 fps
Light type	red
Brennweite	6 mm

**Wiring diagram**

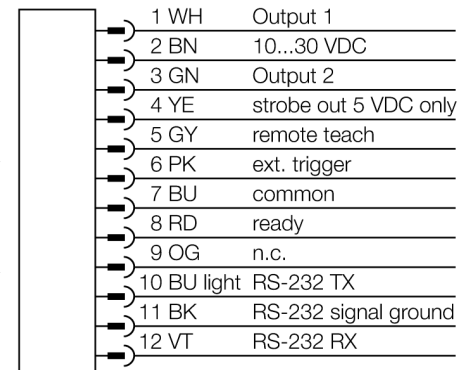

**Functional principle**

The barcode reader consists of a camera and an integrated light (not IVUPRBR version) able to scan up to 10 different barcodes and to transmit the data via Ethernet IP interface. A selection can be configured for certain barcode types such as DataMatrix (ECC 200) and a number of linear codes such as Code128, Code39, CODABAR, Interleaved 2 of 5, EAN13, EAN8, UPCE, Postnet, IMB and Pharmacode.

Sensor configuration via PC is not required! Transmission of log files and firmware updates via USB interface.

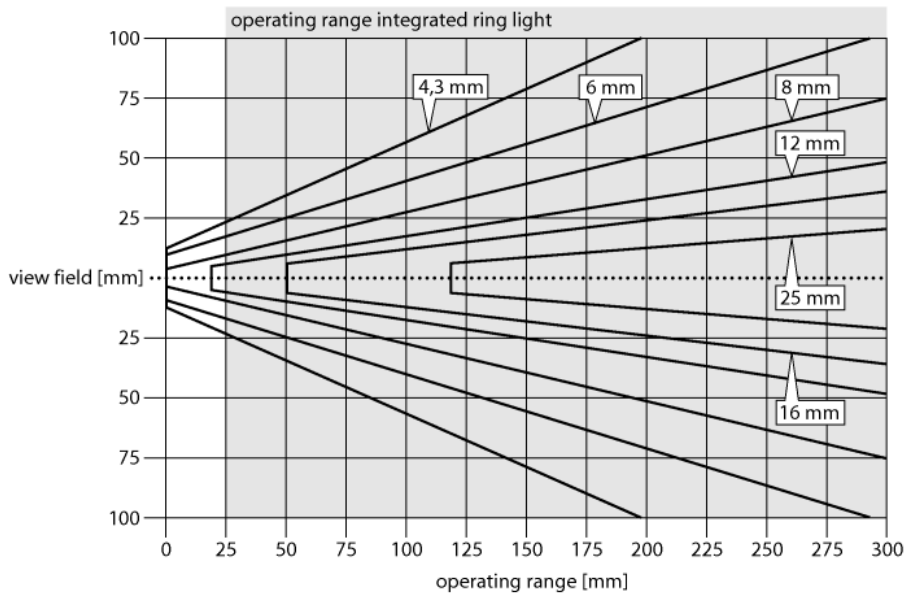

**Selecting the focal length**

With known object size or scan field the matching vision sensor is found simply by determining the ratio between the sensing range and the focal length. Use the graphics for selection. Here, the sensing ranges are put in relation to the field view and the lens focal length.

**Accessories**

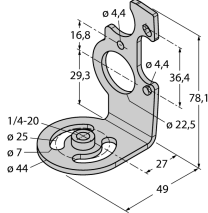
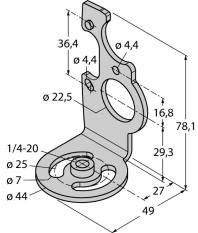
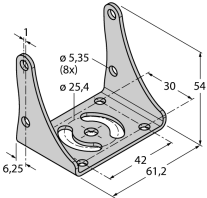
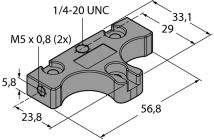
Type code	Ident no.	Description	Dimension drawing
SMBIVURAR	3082547	Brackets for mounting on right side	 <p>Technical drawing of the SMBIVURAR bracket. Dimensions include: top hole diameter <math>\phi 4,4</math>, top hole offset 16,8, mounting hole diameter <math>\phi 22,5</math>, mounting hole offset 36,4, total height 78,1, bottom hole diameter <math>\phi 44</math>, bottom hole offset 29,3, and bottom hole diameter <math>\phi 25</math>. A 1/4-20 thread is indicated.</p>
SMBIVURAL	3082546	Brackets for mounting on left side	 <p>Technical drawing of the SMBIVURAL bracket. Dimensions include: top hole diameter <math>\phi 4,4</math>, top hole offset 36,4, mounting hole diameter <math>\phi 22,5</math>, mounting hole offset 16,8, total height 78,1, bottom hole diameter <math>\phi 44</math>, bottom hole offset 29,3, and bottom hole diameter <math>\phi 25</math>. A 1/4-20 thread is indicated.</p>
SMBIVUU	3082549	U-bracket for base mounting (incl. SMBIVUB baseplate)	 <p>Technical drawing of the SMBIVUU U-bracket. Dimensions include: top hole diameter <math>\phi 5,35</math> (8x), mounting hole diameter <math>\phi 25,4</math>, total height 54, bottom hole diameter <math>\phi 42</math>, and bottom hole diameter <math>\phi 61,2</math>. A 6,25 offset is shown.</p>
SMBIVUB	3082548	Baseplate to extend the installation	 <p>Technical drawing of the SMBIVUB baseplate. Dimensions include: top hole diameter <math>\phi 15</math>, mounting hole diameter <math>\phi 29</math>, total height 33,1, bottom hole diameter <math>\phi 23,8</math>, and bottom hole diameter <math>\phi 56,8</math>. A 5,8 offset is shown. A 1/4-20 UNC thread and M5 x 0,8 (2x) holes are indicated.</p>

**Wiring accessories**

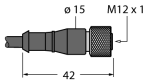
Type code	Ident no.	Description	Dimension drawing
IVUC-1206	3014407	Power supply, M12x1 female, 12-pole, 1.83m	 <p>Technical drawing of the IVUC-1206 power supply connector. Dimensions include: top hole diameter <math>\phi 15</math>, mounting hole diameter <math>\phi 29</math>, total height 33,1, bottom hole diameter <math>\phi 23,8</math>, and bottom hole diameter <math>\phi 56,8</math>. A 5,8 offset is shown. A 1/4-20 UNC thread and M5 x 0,8 (2x) holes are indicated.</p>

**Wiring accessories**

Type code	Ident no.	Description	Dimension drawing
IVUC-E-406	3013892	Ethernet connection cable, M8x1 on RJ45, 4-pole, 2m	
PSG-4M-401-USB	3011336	USB adapter cable, male M12x1, 4-pole, 0.3m	
IVURDM-QD-803	3028673	Remote Display, M12 x 1, 8-pin, 0.91 m	

**Function accessories**

Type code	Ident no.	Description	Dimension drawing
RDM35	3029512		