

Miniature Pressure and Vacuum Switch, Type "Airtrol®"

F4200

Description	High-precision pressure and vacuum switch with electrical outlet signal. The microswitch satisfies UL and CSA regulations. Polysulphone of the body approved by National Sanitation Foundation. The switch also complies with FDA regulations and is suitable for water and food products.		
Media	compressed air, non-corrosive gases or liquids		
Switch contact	micro SPDT switch, covered by plastic cap		
Contact load	3 A at 230 V AC or 1.2 A at 125 V DC 10 A at 230 V AC or 0.5 A at 125 V DC		
Electrical connector	0.187" (4.75 mm) quick connector for Molex connector		
Repeatability	± 2% FS		
Certifications	CSA-certified and UL-listed		
Switching time	25 ms		
Mounting position	any		
Temperature range	4 °C to 66 °C / 40 °F to 150 °F		
Material	Body: polysulphone	Spring: stainless steel	Media non-contact parts: nylon, carbon fibre nylon, acetal
	Diaphragm: polyurethane		

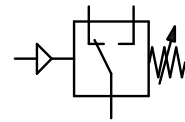

3 ... 30 mbar / 7 bar
-1 ... -10 mbar / -1 bar

Description	Contact load	Hysteresis typical	Hysteresis max.	Over-pressure max. bar	Measurement range bar	Order number
	max. A	mbar	mbar	max. bar	bar	

Pressure and Vacuum Switch	pressure port 1/8" NPT male, with covering cap, SPDT switch	F4200
pressure switch	3	3 10 1 0.003 ... 0.03 F4200- 0,5PT
	10	7 20 2 0.014 ... 0.14 F4200- 2PT
	10	30 50 2 0.035 ... 0.35 F4200- 5PT
	10	70 110 3 0.035 ... 1.0 F4200- 15PT
	10	120 160 4 0.035 ... 2.1 F4200- 30PT
	10	240 350 8 0.035 ... 4.2 F4200- 60PT
	10	400 500 8 0.070 ... 7.0 F4200-100PT
vacuum switch	3	1 3 -0.3 -0.001 ... -0.01 F4200-X 4PT
	10	17 27 -1 -0.007 ... -0.17 F4200-X 5PT
	10	34 50 -1 -0.015 ... -0.34 F4200-X10PT
	10	68 100 -1 -0.050 ... -1.00 F4200-X30PT



F4200-100PT



F4200-60FEM



F4200-100PM



F4200-100MM

Special options, add or change the appropriate letter

flush mounting	barbed fitting made of nylon, Ø 1/16", Ø 2 mm	F4200-... FMB80
panel mounting	barbed fitting made of nylon, Ø 1/16", Ø 2 mm	F4200-... PMB80
manifold mounting		F4200-... MM
barbed fittings	for FM and PM, made of nylon, Ø 1/16", Ø 2 mm	F4200-... B80
	nylon, Ø 1/8", Ø 4 mm	F4200-... B85
	polysulphone, Ø 1/16", Ø 2 mm	F4200-... P80
	polysulphone, Ø 1/8", Ø 4 mm	F4200-... P85
gold contact		F4200-... .1B
factory-set switchpoint	± 5%, indicate on order	F4200-... .X
free of oil and grease	specially cleaned, suitable for oxygen	F4200-... .L

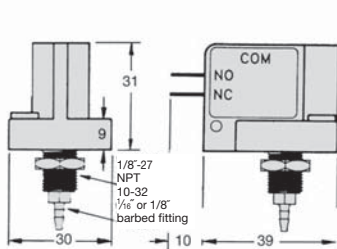

F4200-PM

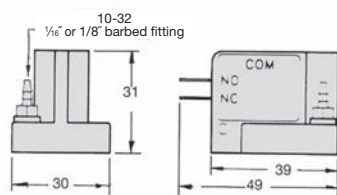

F4200-FM

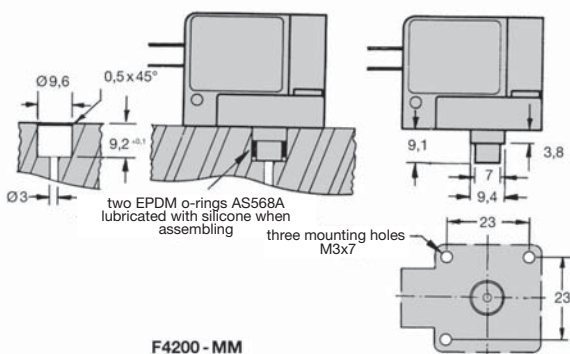

F4200-MM

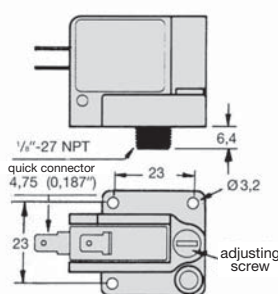

F4200-PT

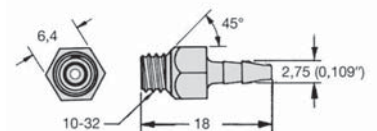

B80 / P80

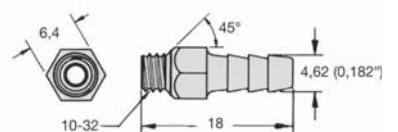

B85 / P85

PDF CAD
www.aircom.net



Order example:
F4200-0,5PT