



# INDUCTIVE SENSORS ANALOG

## TABLE OF CONTENTS

### Designation code

How to read sensor designations

3

### Circuit diagrams

Termination according to EN 60947-5-2

4

### Sensors

Programmable analog sensors	5
Cylinder G6,5 analog voltage output (ANU)	6
Cylinder M8 analog voltage output (ANU)	7
Cylinder M12 analog voltage output (ANU)	8
Cylinder M12 analog current output (ANI)	9
Cylinder M18 analog voltage output (ANU)	10
Cylinder M18 analog current output (ANI)	11
Cylinder M30 analog voltage output (ANU)	12
Cylinder M30 analog current output (ANI)	14
Square Q40 analog voltage output (ANU)	15
Cylinder M18, M30 analog voltage and current output (ANUI)	16
Square Q40 analog voltage and current output (ANUI)	18



# INDUCTIVE SENSORS ANALOG

## DESIGNATION CODE

Example: **K J 10 - M 30 M B 45 - D P S - V1 - X0000**

1	2	3	4	5	6	7	8	9	10	11	12

### 1 = Working principle

<b>A</b>	Acoustic
<b>B</b>	Acceleration sensor
<b>C</b>	Capacitive
<b>D</b>	Strain gauge sensor
<b>H</b>	Hall-effect
<b>J</b>	Inductive
	<b>JR</b> Inductive ring
	<b>JF</b> Inductive surface
	<b>JG</b> Inductive slot
	<b>JD</b> Metalface
<b>M</b>	Magneto-resistive
<b>N</b>	Inclination sensor
<b>R</b>	Reed-contact
<b>W</b>	Angle sensor

### 2 = Switching distance / range

### 3 = Design

<b>D</b>	Ring housing
<b>G</b>	Cylindrical housing without thread
<b>M</b>	Cylindrical housing with metrical thread
<b>Q</b>	Square housing

### 4 = Housing diameter / edge length

### 5 = Housing material

<b>A</b>	Aluminium
<b>E</b>	Stainless steel
<b>K</b>	Plastic
<b>M</b>	Brass, nickel plated
<b>T</b>	PTFE

### 6 = Installation

<b>B</b>	Shielded
<b>N</b>	Non shielded

### 7 = Tube length

### 8 = Operating voltage

<b>AZ</b>	AC alternating current voltage
<b>D</b>	DC direct current voltage
<b>VZ</b>	AC/DC all voltages

### 9 = Type of output signal

<b>AN</b>	Analog	<b>ANI</b>	Current output
		<b>ANU</b>	Voltage output
<b>N</b>	NPN	<b>CAN</b>	CAN-bus interface
<b>NA</b>	Namur		
<b>P</b>	PNP		
<b>Z</b>	Two wire		

### 10 = Function

<b>A</b>	Changeover
<b>I</b>	Impulse output
<b>Ö</b>	N.C.
<b>S</b>	N.O.
<b>U</b>	Switchable

### 11 = Termination

<b>V1</b>	M8 screw-/snap-in
<b>V2</b>	M12 metal
<b>V2/1</b>	M12 plastic
<b>V3</b>	M5 metal
<b>V4</b>	Amphenol Tuchel
<b>V6</b>	Brad Harrison
<b>V7</b>	Valve connector type A
<b>V8</b>	M8 snap-in only
<b>V9</b>	Torson
<b>V10</b>	Valve connector type C
<b>V11</b>	AC connector 1/2" UNF
<b>V12</b>	M18 plastic
<b>VE</b>	Euchner connector
<b>RS232</b>	Data interface
<b>PG</b>	Thread joint PG
<b>Mxx</b>	Thread joint metrical

others as requested

### 12 = Additional marks

<b>AM</b>	Sensing face in centre
<b>FE</b>	Reduction 1 to steel / iron
<b>HT</b>	High temperature
<b>NF</b>	Reduction 1 to nonferrous metal
<b>SF</b>	Weld field immune
<b>T</b>	Enlarged temperature range
<b>W</b>	Angled sensing face / angled cable exit
<b>X</b>	Customized design with detailed description



# INDUCTIVE SENSORS ANALOG

## CIRCUIT DIAGRAMS

Circuit diagram for	Cable / clamp connection	Connector V1 ... V9
DPS DC PNP N.O.		
DPÖ DC PNP N.C.		
DPA DC PNP changeover		
DPU DC NO/NC switchable		
DNS DC NPN N.O.		
DNÖ DC NPN N.C.		
DNA DC NPN changeover		
DNU DC NO/NC switchable		
NA Namur EN 60947-5-6		
DZS DC two-wire N.O.		
DZÖ DC two-wire N.C.		
AZS/VZS AC/DC two-wire N.O.		
AZÖ/VZÖ AC/DC two-wire N.C.		
Analog		



# INDUCTIVE SENSORS ANALOG

## PROGRAMMABLE ANALOG SENSORS

### Technical data

With four programmable switching points and an enlarged switching distance this sensor provides for large flexibility. Depending on the application the switching points can be configured as normally open or normally close contact. Current and voltage values can be set freely within the thresholds. The user realises any desired output characteristics until an ideal linearity in the application is attained. By programming a switching window the user is able to gate out unwanted measured data.



<b>Article number</b>	<b>Designation</b>
08317144730	<b>KJ10-M18MN60-ANU-DPSS</b>
<b>Mounting</b>	non shielded
<b>Output signal</b>	0 ... 10V
<b>Operating voltage <math>U_b</math></b>	11 ... 30V DC
<b>Ripple voltage of <math>U_b</math></b>	$\leq 5\%$
<b>Reverse voltage protection</b>	between + and -
<b>Linearity</b>	$\leq 3\%$
<b>Off-state current <math>I_0</math></b>	$\leq 10,0\text{mA}$ (typ. 4 ... 5mA)
<b>Operating current <math>I_e</math></b>	$\leq 10\text{mA}$
<b>Internal resistor <math>R_i</math></b>	$\leq 500\text{Ohm}$
<b>Operating frequency <math>f</math></b>	200Hz
<b>Switching distance</b>	0,5 ... 10,0mm
<b>Repeat accuracy <math>R</math></b>	$\leq 1\%$
<b>Average Rising</b>	1,05V / mm +/- 5%
<b>Operating temperature <math>T_a</math></b>	-25°C ... +70°C
<b>Temperature drift</b>	+/- 8%
<b>Protection class</b>	IP67
<b>EMV-standard</b>	according to IEC 60947-5-7
<b>Housing material</b>	brass, nickel-plated
<b>Front cap</b>	PA 6.6
<b>Termination</b>	2m cable PVC 4 x 0,34mm <sup>2</sup>

Other cable lengths as requested.

### Dimensions

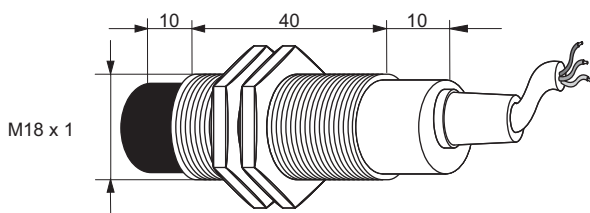

# NEW



# INDUCTIVE SENSORS ANALOG

## CYLINDER G6,5 ANALOG VOLTAGE OUTPUT (ANU)

### Technical data

<b>Article number</b>	<b>Designation</b>
08317140050	KJ2-G6,5MB40-ANU
<b>Mounting</b>	shielded
<b>Output signal</b>	0V ... 10V
<b>Operating voltage <math>U_b</math></b>	11V ... 35V DC
<b>Ripple voltage of <math>U_b</math></b>	$\leq 5\%$
<b>Reverse voltage protection</b>	between + and -
<b>Linearity</b>	$\leq 3\%$
<b>Off-state current <math>I_0</math></b>	10,0mA (typ. 4 ... 5mA)
<b>Operating frequency <math>f</math></b>	400Hz
<b>Switching distance</b>	0,5 ... 2mm
<b>Repeat accuracy <math>R</math></b>	$\leq 1\%$
<b>Average rising</b>	6,66V / mm
<b>Operating temperature <math>T_a</math></b>	-25°C ... +70°C
<b>Temperature drift</b>	+/- 8%
<b>Protection class</b>	IP67
<b>EMV-standard</b>	according to IEC 60947-5-7
<b>Housing material</b>	brass, nickel-plated
<b>Front cap</b>	PA 6.6
<b>Termination</b>	2m cable PVC 3 x 0,14mm <sup>2</sup>



Other cable lengths as requested.

### Dimensions

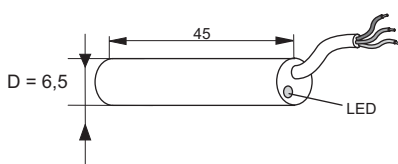





# INDUCTIVE SENSORS ANALOG

## CYLINDER M8 ANALOG VOLTAGE OUTPUT (ANU)

### General data

Mounting	shielded
Output signal	0V ... 10V
Operating voltage $U_b$	11V ... 35V DC
Ripple voltage of $U_b$	$\leq 5\%$
Reverse voltage protection	between + and -
Linearity	$\leq 3\%$
Off-state current $I_0$	10,0mA (typ. 4 ... 5mA)
Operating frequency $f$	400Hz
Switching distance	0,5 ... 2mm
Repeat accuracy $R$	$\leq 1\%$
Average rising	6,66V / mm
Operating temperature $T_a$	-25°C ... +70°C
Temperature drift	+/- 8%
Protection class	IP67
EMV-standard	according to IEC 60947-5-7
Housing material	brass, nickel-plated
Front cap	PA 6.6



### Selection chart

Article number	Designation	Termination	Drawing
08317140000	<b>KJ2-M8MB40-ANU</b>	2m cable PVC 3 x 0,14mm <sup>2</sup>	A
08317140064	<b>KJ2-M8MB60-ANU-V1</b>	Connector M8 3-pole	B

### Dimensions

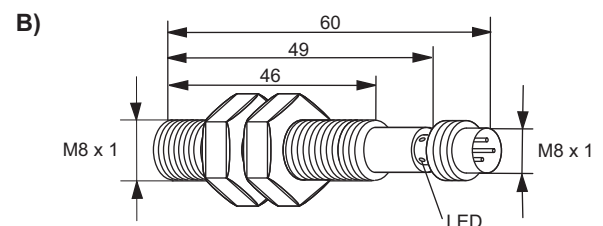
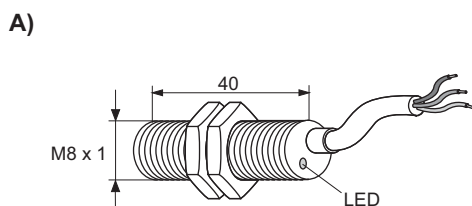



# INDUCTIVE SENSORS ANALOG

## CYLINDER M12 ANALOG VOLTAGE OUTPUT (ANU)

### General data

Output signal	1V ... 9V
Operating voltage $U_b$	11V ... 35V DC
Ripple voltage of $U_b$	$\leq 10\%$
Reverse voltage protection	yes
Linearity	$\leq 5\%$
Off-state current $I_0$	$\leq 5\text{mA}$
Operating frequency $f$	KJ3... 500Hz KJ4... 400Hz
Repeat accuracy $R$	$\leq 1\%$
Average rising	KJ3... 2,91V / mm KJ4... 2,28V / mm
Operating temperature $T_a$	-25°C ... +70°C
Temperature drift	+/- 5%
Protection class	IP67
EMV-standard	according to EN 60947-5-7
Housing material	brass, nickel-plated
Front cap	PCP



### Selection chart

Article number	Designation	Mounting	Switching distance in mm	Termination	Drawing
08317143800	<b>KJ3-M12MB50-ANU</b>	shielded	0,25 ... 3	2m cable PVC 3 x 0,34mm <sup>2</sup>	A
08317143865	<b>KJ3-M12MB60-ANU-V2</b>	shielded	0,25 ... 3	Connector M12 4-pole	A1
08317144800	<b>KJ4-M12MN50-ANU</b>	non shielded	0,5 ... 4	2m cable PVC 3 x 0,34mm <sup>2</sup>	B
08317144865	<b>KJ4-M12MN60-ANU-V2</b>	non shielded	0,5 ... 4	Connector M12 4-pole	B1

Other cable lengths as requested.

### Dimensions

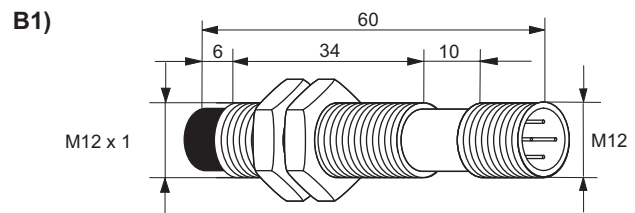
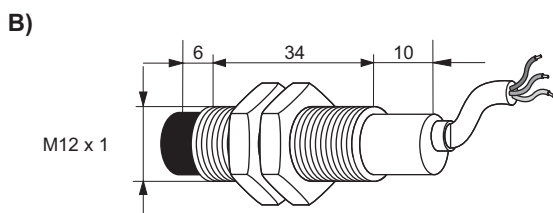
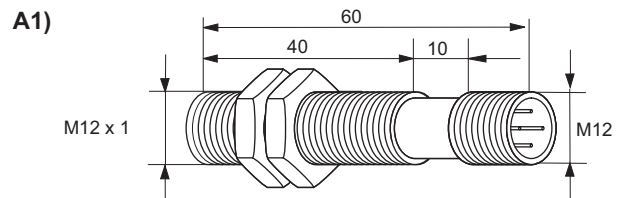
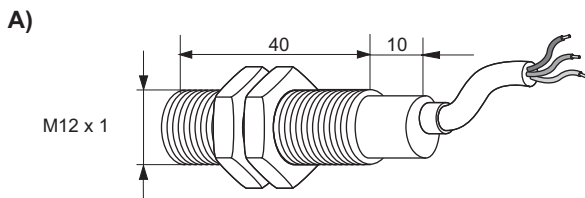

alle data in mm



# INDUCTIVE SENSORS ANALOG

## CYLINDER M12 ANALOG CURRENT OUTPUT (ANI)

### General data

Output signal	4 ... 20mA
Operating voltage $U_b$	10 ... 35V DC
Ripple voltage of $U_b$	$\leq 10\%$
Reverse voltage protection	yes
Linearity	$\leq 5\%$
Off-state current $I_0$	$\leq 10\text{mA}$
Operating frequency $f$	KJ3... 450Hz KJ4... 400Hz
Repeat accuracy $R$	$\leq 1\%$
Average rising	KJ3... 5,82mA / mm KJ4... 4,57mA / mm
Operating temperature $T_a$	-25°C ... +70°C
Temperature drift	+/- 5%
Protection class	IP67
EMV-standard	according to EN 60947-5-7
Housing material	brass, nickel-plated
Front cap	PCP



### Selection chart

Article number	Designation	Mounting	Switching distance in mm	Termination	Drawing
08317141800	<b>KJ3-M12MB50-ANI</b>	shielded	0,25 ... 3	2m cable PVC 3 x 0,34mm <sup>2</sup>	A
08317141865	<b>KJ3-M12MB60-ANI-V2</b>	shielded	0,25 ... 3	Connector M12 4-pole	A1
08310000287	<b>KJ4-M12MN50-ANI</b>	non shielded	0,5 ... 4	2m cable PVC 3 x 0,34mm <sup>2</sup>	B
08310001033	<b>KJ4-M12MN60-ANI-V2</b>	non shielded	0,5 ... 4	Connector M12 4-pole	B1

Other cable lengths as requested.

### Dimensions

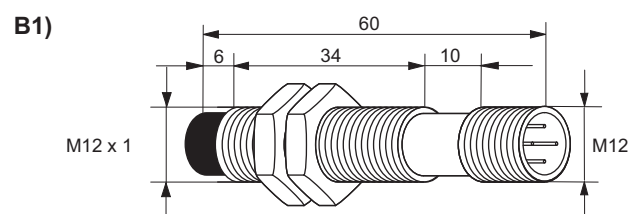
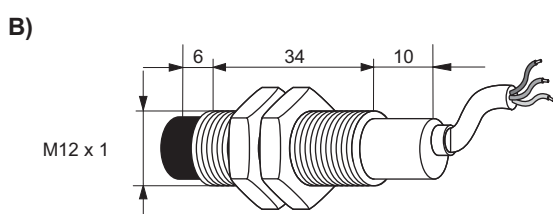
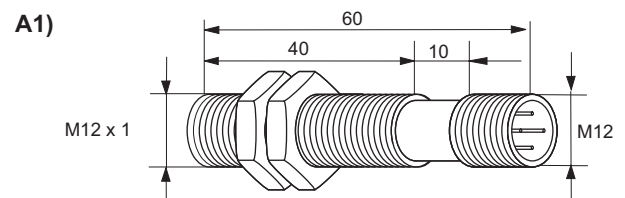
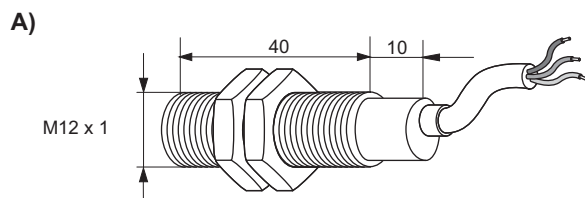

all data in mm





# INDUCTIVE SENSORS ANALOG

## CYLINDER M18 ANALOG VOLTAGE OUTPUT (ANU)

### General data

Output signal	1V ... 9V
Operating voltage $U_b$	11V ... 35V DC
Ripple voltage of $U_b$	$\leq 10\%$
Reverse voltage protection	yes
Linearity	$\leq 5\%$
Off-state current $I_0$	$\leq 5\text{mA}$
Operating frequency $f$	KJ5... 500Hz KJ8... 400Hz
Repeat accuracy $R$	$\leq 1\%$
Average rising	KJ5... 1,778V / mm KJ8... 1,143V / mm
Operating temperature $T_a$	-25°C ... +70°C
Temperature drift	+/- 5%
Protection class	IP67
EMV-standard	according to EN 60947-5-7
Housing material	brass, nickel-plated
Front cap	PCP



### Selection chart

Article number	Designation	Mounting	Switching distance in mm	Termination	Drawing
08317143700	<b>KJ5-M18MB50-ANU</b>	shielded	0,5 ... 5	2m cable PVC 3 x 0,34mm <sup>2</sup>	A
08317143765	<b>KJ5-M18MB61-ANU-V2</b>	shielded	0,5 ... 5	Connector M12 4-pole	A1
08317144700	<b>KJ8-M18MN50-ANU</b>	non shielded	1 ... 8	2m cable PVC 3 x 0,34mm <sup>2</sup>	B
08317144765	<b>KJ8-M18MN61-ANU-V2</b>	non shielded	1 ... 8	Connector M12 4-pole	B1

Other cable lengths as requested.

### Dimensions

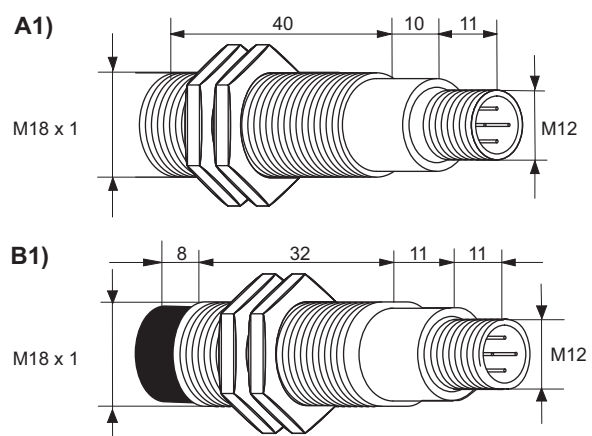
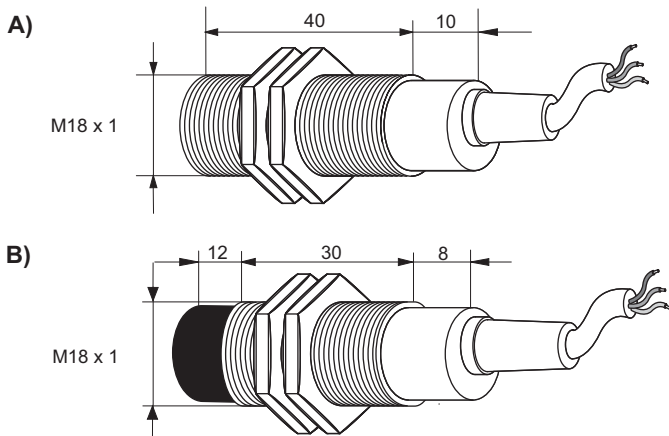

all data in mm



# INDUCTIVE SENSORS ANALOG

## CYLINDER M18 ANALOG CURRENT OUTPUT (ANI)

### General data

Output signal	4 ... 20mA
Operating voltage $U_b$	10V ... 35V DC
Ripple voltage of $U_b$	$\leq 10\%$
Reverse voltage protection	yes
Linearity	$\leq 5\%$
Off-state current $I_0$	$\leq 10\text{mA}$
Operating frequency $f$	400Hz
Repeat accuracy R	$\leq 1\%$
Average rising	KJ5... 3,56mA / mm KJ8... 2,29mA / mm
Operating temperature $T_a$	-25°C ... +70°C
Temperature drift	+/- 5%
Protection class	IP67
EMV-standard	according to EN 60947-5-7
Housing material	brass, nickel-plated
Front cap	PCP



### Selection chart

Article number	Designation	Mounting	Switching distance in mm	Termination	Drawing
08317141700	<b>KJ5-M18MB50-ANI</b>	shielded	0,5 ... 5	2m cable PVC 3 x 0,34mm <sup>2</sup>	A
08317141765	<b>KJ5-M18MB61-ANI-V2</b>	shielded	0,5 ... 5	Connector M12 4-pole	A1
08310000293	<b>KJ8-M18MN50-ANI</b>	non shielded	1 ... 8	2m cable PVC 3 x 0,34mm <sup>2</sup>	B
08310001031	<b>KJ8-M18MN61-ANI-V2</b>	non shielded	1 ... 8	Connector M12 4-pole	B1

Other cable lengths as requested.

### Dimensions

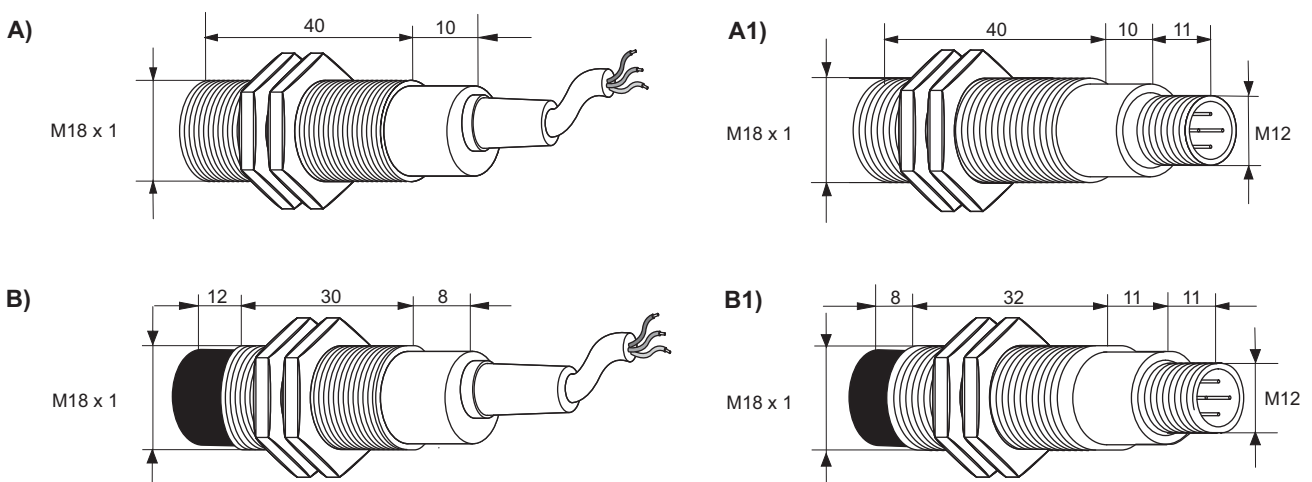

alle data in mm



# INDUCTIVE SENSORS ANALOG

## CYLINDER M30 ANALOG VOLTAGE OUTPUT (ANU)

### General data

<b>Output signal</b>	1V ... 9V	
<b>Operating voltage <math>U_b</math></b>	KJ9...	11 ... 35V DC
	KJ14...	18 ... 30V DC
	KJ15...	11 ... 35V DC
<b>Ripple voltage of <math>U_b</math></b>	≤ 10%	
<b>Reverse voltage protection</b>	yes	
<b>Linearity</b>	≤ 5%	
<b>Off-state current <math>I_0</math></b>	KJ9...	5mA
	KJ14...	≤ 10mA
	KJ15...	≤ 5mA
<b>Repeat accuracy R</b>	≤ 1%	
<b>Average rising</b>	KJ9...	1V / mm
	KJ14 ... (4BIT)	1,14V / mm
	KJ15...	0,667V / mm
<b>Operating temperature <math>T_a</math></b>	-25°C ... +70°C	
<b>Temperature drift</b>	+/- 5%	
<b>Protection class</b>	IP67	
<b>EMV-standard</b>	according to EN 60947-5-7	
<b>Housing material</b>	brass, nickel-plated	
<b>Frontcap</b>	PCP	



The drawings of these sensors are shown on the following page.

### Selection chart

Article number	Designation M30 Switching distance 1 ... 9mm	Mounting	Operating frequency	Termination	Drawing (following page)
08317143600	<b>KJ9-M30MB40-ANU</b>	shielded	400Hz	2m cable PVC 3 x 0,34mm <sup>2</sup>	A
08317143665	<b>KJ9-M30MB50-ANU-V2</b>	shielded	400Hz	Connector M12 4-pole	A1

	Designation M30 Switching distance 7 ... 14mm				
08317140500	<b>KJ14-M30MN80-ANU-F1*</b>	non shielded	100Hz	2m cable PVC 3 x 0,14mm <sup>2</sup>	B
08317140600	<b>KJ14-M30MN80-ANU-F2*</b>	non shielded	100Hz	2m cable PVC 3 x 0,14mm <sup>2</sup>	B
08317141000	<b>KJ14-M30MN80-ANU 4BIT**</b>	non shielded	30Hz	2m cable PVC 7 x 0,14mm <sup>2</sup>	B

\* several working frequencies for opposed mounting

\*\* with additional 4 BIT NPN-digital output

	Designation M30 Switching distance 3 ... 15mm				
08317144600	<b>KJ15-M30MN40-ANU</b>	non shielded	300Hz	2m cable PVC 3 x 0,34mm <sup>2</sup>	C
08317144665	<b>KJ15-M30MN50-ANU-V2</b>	non shielded	300Hz	Connector M12 4-pole	C1

Other cable lengths as requested.



# INDUCTIVE SENSORS ANALOG

## CYLINDER M30 ANALOG VOLTAGE OUTPUT (ANU)

### Dimensions

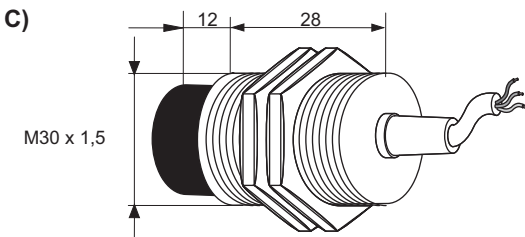
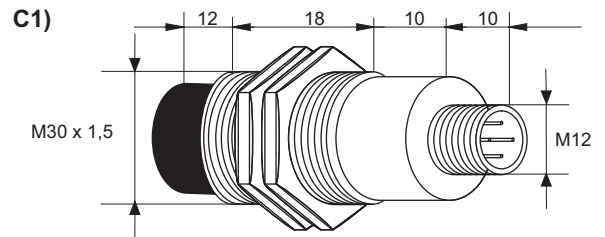
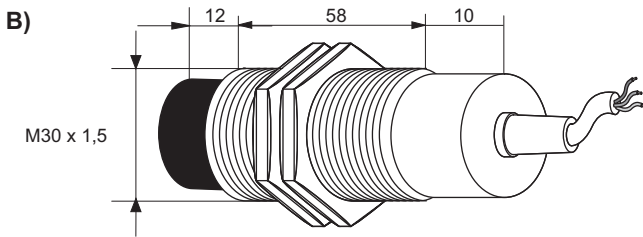
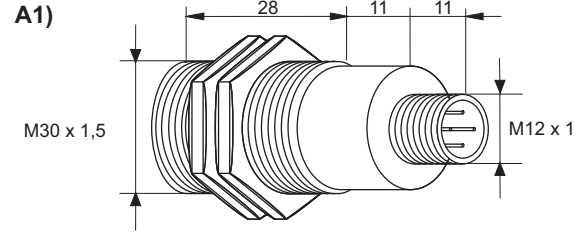
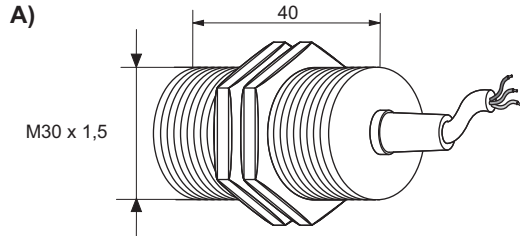





# INDUCTIVE SENSORS ANALOG

## CYLINDER M30 ANALOG CURRENT OUTPUT (ANI)

### General data

Output signal	4 ... 20mA
Operating voltage $U_b$	10V ... 35V DC
Ripple voltage of $U_b$	$\leq 10\%$
Reverse voltage protection	yes
Linearity	$\leq 5\%$
Off-state current $I_0$	$\leq 10\text{mA}$
Operating frequency $f$	KJ9... 350Hz KJ15... 300Hz
Repeat accuracy $R$	$\leq 1\%$
Average rising	KJ9... 2mA / mm KJ15... 1,33mA / mm
Operating temperature $T_a$	-25°C ... +70°C
Temperature drift	+/- 5%
Protection class	IP67
EMV-standard	according to EN 60947-5-7
Housing material	brass, nickel-plated
Front cap	PCP



### Selection chart

Article number	Designation	Mounting	Switching distance in mm	Termination	Drawing
08317141600	<b>KJ9-M30MB40-ANI</b>	shielded	1 ... 9	2m cable PVC 3 x 0,34mm <sup>2</sup>	A
08317141665	<b>KJ9-M30MB50-ANI-V2</b>	shielded	1 ... 9	Connector M12 4-pole	A1
08310000294	<b>KJ15-M30MN40-ANI</b>	non shielded	3 ... 15	2m cable PVC 3 x 0,34mm <sup>2</sup>	B
08310001032	<b>KJ15-M30MN50-ANI-V2</b>	non shielded	3 ... 15	Connector M12 4-pole	B1

Other cable lengths as requested.

### Dimensions

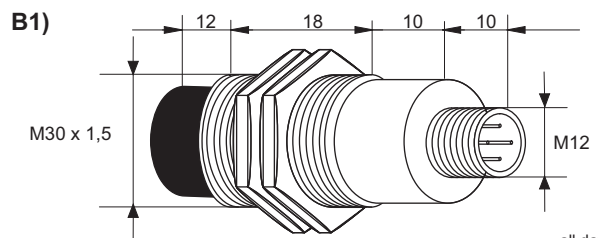
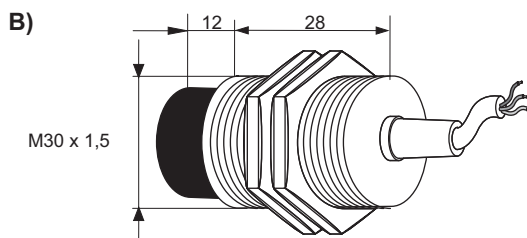
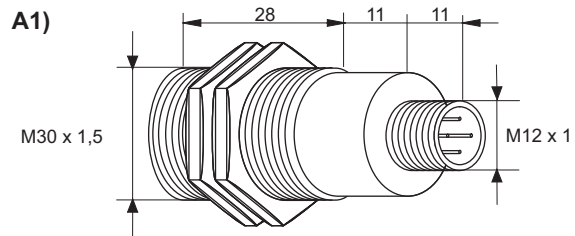
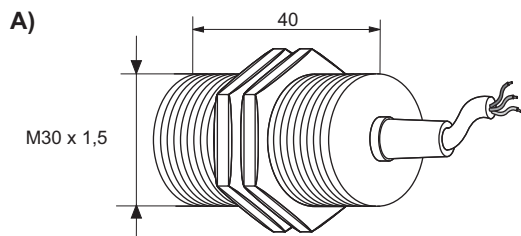

all data in mm





# INDUCTIVE SENSORS ANALOG

## SQUARE Q40 ANALOG VOLTAGE OUTPUT (ANU)

### Technical data

<b>Article number</b>	<b>Designation</b>
08317141100	KJ20-Q40KN-ANU
<b>Mounting</b>	non shielded
<b>Output signal</b>	1 ... 9V
<b>Operating voltage <math>U_b</math></b>	18 ... 30V DC
<b>Ripple voltage of <math>U_b</math></b>	$\leq 10\%$
<b>Reverse voltage protection</b>	between + und -
<b>Linearity</b>	$\leq 5\%$
<b>Off-state current <math>I_0</math></b>	$\leq 10\text{mA}$
<b>Operating frequency <math>f</math></b>	25Hz
<b>Switching distance</b>	10 ... 20mm
<b>Repeat accuracy <math>R</math></b>	$\leq 5\%$
<b>Average rising</b>	0,8V / mm
<b>Operating temperature <math>T_a</math></b>	-25°C ... +70°C
<b>Temperature drift</b>	+/- 5%
<b>Protection class</b>	IP67
<b>EMV-standard</b>	according to EN 60947-5-7
<b>Housing material</b>	Trogamid
<b>Termination</b>	Terminals 1,5mm <sup>2</sup>



### Dimensions

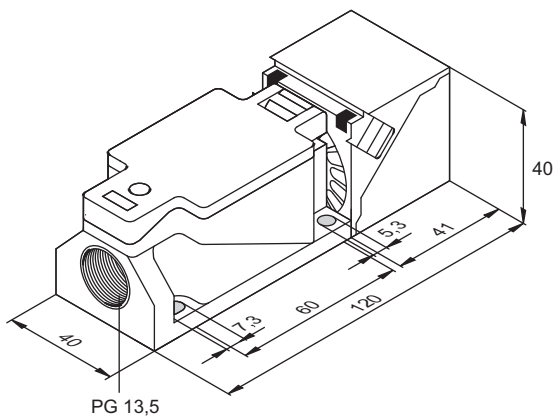



## INDUCTIVE SENSORS ANALOG

### CYLINDER ANALOG VOLTAGE AND CURRENT OUTPUT (ANUI)

#### General data

<b>Output signal</b>	0 ... 10V 4 ... 20mA
<b>Operating voltage <math>U_b</math></b>	18V ... 30V DC
<b>Ripple voltage of <math>U_b</math></b>	$\leq 10\%$
<b>Reverse voltage protection</b>	yes
<b>Linearity</b>	$\leq 10\%$
<b>Off-state current <math>I_0</math></b>	$\leq 15\text{mA}$
<b>Operating frequency <math>f</math></b>	SJ4... 100Hz SJ7... 30Hz SJ10... 100Hz SJ14... 30Hz
<b>Repeat accuracy <math>R</math></b>	$\leq 0,02\%$
<b>Average Rising</b>	SJ4... 3,3V /mm / 6,66mA/mm SJ7... 1,66V /mm / 3,33mA/mm SJ10... 2V /mm / 4mA/mm SJ14... 1,43V /mm / 2,86mA/mm
<b>Operating temperature <math>T_a</math></b>	0°C ... +70°C
<b>Temperature drift</b>	+/- 5%
<b>Protection class</b>	IP67
<b>EMV-standard</b>	according to EN 60947-5-7
<b>Housing material</b>	brass, nickel-plated
<b>Front cap</b>	PBT
<b>Termination</b>	2m cable PUR 4 x 0,5mm <sup>2</sup>



The drawings of these sensors are shown on the following page.

#### Selection chart

Article number	Designation	Mounting	Switching distance in mm	Drawing (following page)
08313180410	<b>SJ4-M18MB80-ANUI</b>	shielded	1 ... 4	A
08313180710	<b>SJ7-M18MN80-ANUI</b>	non shielded	1 ... 7	B
08313103010	<b>SJ10-M30MB80-ANUI</b>	shielded	5 ... 10	C
08313301410	<b>SJ14-M30MN80-ANUI</b>	non shielded	7 ... 14	D

Other cable lengths as requested.



# INDUCTIVE SENSORS ANALOG

## CYLINDER ANALOG VOLTAGE AND CURRENT OUTPUT (ANUI)

### Dimensions

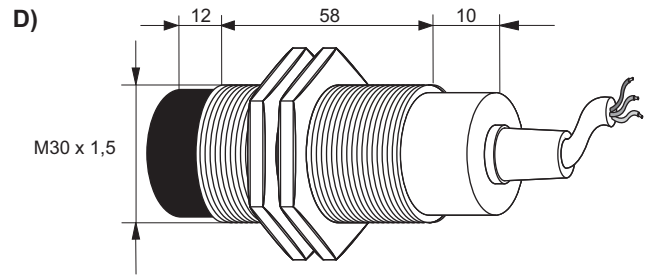
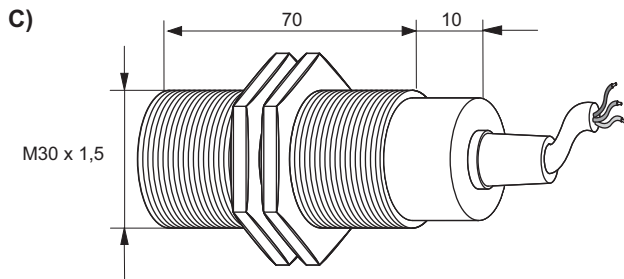
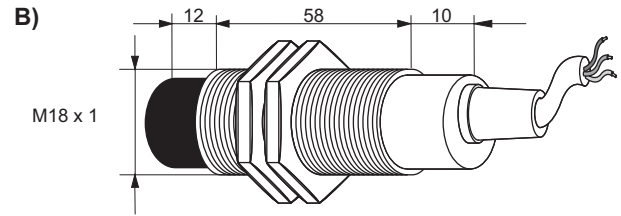
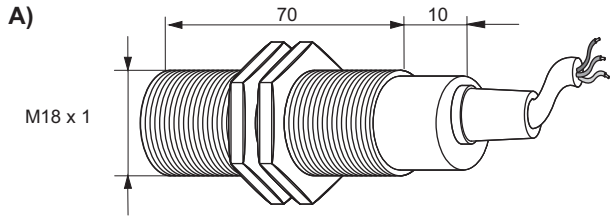



## INDUCTIVE SENSORS ANALOG

### SQUARE ANALOG VOLTAGE AND CURRENT OUTPUT (ANUI)

#### Technical data

<b>Article number</b>	<b>Designation</b>
08313204010	SJ20-Q40KN-ANUI
<b>Mounting</b>	non shielded
<b>Output signal</b>	0 ... 10V 0mA ... 20mA
<b>Operating voltage <math>U_b</math></b>	18 ... 30V DC
<b>Ripple voltage of <math>U_b</math></b>	$\leq 10\%$
<b>Reverse voltage protection</b>	yes
<b>Linearity</b>	0%
<b>Off-state current <math>I_0</math></b>	$\leq 15\text{mA}$
<b>Operating frequency <math>f</math></b>	30Hz
<b>Switching distance</b>	10 ... 20mm
<b>Repeat accuracy <math>R</math></b>	$\leq 0,02\%$
<b>Average rising</b>	$0,77\text{V} / \text{mm} = 1,54 \text{ mA} / \text{mm}$
<b>Operating temperature <math>T_a</math></b>	$0^\circ\text{C} \dots +70^\circ\text{C}$
<b>Temperature drift</b>	$\pm 5\%$
<b>Protection class</b>	IP67
<b>EMV-standard</b>	according to EN 60947-5-7
<b>Housing material</b>	PBT
<b>Termination</b>	Terminals 1,5mm <sup>2</sup>



#### Dimensions

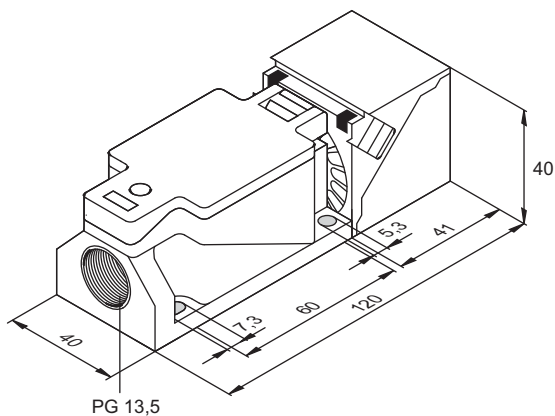

all data in mm